

This **PCB Rework and Repair Guide** has been downloaded from the INTERTRONICS website.

Please visit us for all your rework and repair needs!

www.intertronics.co.uk

intertronics

CIRCUITMEDIC⁺

PC Board Rework and Repair

A Comprehensive Guide
Document No. CRC-20

Revision D

ECN No. 098

Dated January 5, 1998

Published by:

CIRCUIT TECHNOLOGY CENTER, INC.

45 Research Drive, Haverhill MA 01832-1293 USA

Phone: 978.374.5000 x Fax: 978.372.5700

E-Mail: info@circuitnet.com x Web Site: <http://www.circuitnet.com>

Jeff Ferry - President

© Copyright CIRCUIT TECHNOLOGY CENTER, INC. 1996

All rights reserved.

This document may not be copied or reproduced in any form,
in whole or in part, without permission from
CIRCUIT TECHNOLOGY CENTER, INC.

CIRCUIT TECHNOLOGY CENTER, INC.
disclaims all liability associated with the use of this information.

TABLE OF CONTENTS

Types - Printed Board Types

R. Rigid Printed Boards and Assemblies
 F. Flexible Printed Boards and Assemblies
 W. Discrete Wiring Boards and Assemblies
 C. Ceramic Boards and Assemblies

C - Conformance Level

High Highest Level
 Medium Medium Level
 Low Lowest Level

S - Skill Level

I. Intermediate
 A. Advanced
 E. Expert

<u>No.</u>	<u>Title</u>	<u>Types</u>	<u>C</u>	<u>S</u>	<u>Rev</u>
1.0	FOREWORD				D
2.0	BASIC PROCEDURES				
2.1	Handling Electronic Assemblies	R, F, W, C	High	I	C
2.2	Cleaning	R, F, W, C	High	I	C
2.3.1	Coating Removal, Identification Of Coating	R, F, W, C	High	A	C
2.3.2	Coating Removal, Solvent Method	R, F, W, C	High	A	D
2.3.3	Coating Removal, Peeling Method	R, F, W, C	High	A	D
2.3.4	Coating Removal, Thermal Method	R, F, W, C	High	A	D
2.3.5	Coating Removal, Grinding/Scraping Method	R, F, W, C	High	A	D
2.3.6	Coating Removal, Micro Blasting Method	R, F, W, C	High	A	D
2.4.1	Coating Replacement, Solder Mask	R, F, W, C	High	I	D
2.4.2	Coating Replacement, Conformal Coatings/Encapsulants	R, F, W, C	High	I	D
2.5	Baking And Preheating	R, F, W, C	High	I	D
2.6.1	Legend/Marking, Stamping Method	R, F, W, C	High	I	D
2.6.2	Legend/Marking, Hand Lettering Method	R, F, W, C	High	I	C
2.6.3	Legend/Marking, Stencil Method	R, F, W, C	High	I	C
2.7	Epoxy Mixing and Handling	R, F, W, C	High	I	C
3.0	BASE MATERIAL PROCEDURES				
3.1	Delamination/Blister Repair, Injection Method	R	High	A	C
3.2	Bow And Twist Repair	R, W	High	A	C
3.3.1	Hole Repair, Epoxy Method	R, W	High	A	C
3.3.2	Hole Repair, Transplant Method	R, W	High	E	D
3.4.1	Key And Slot Repair, Epoxy Method	R, W	High	A	C
3.4.2	Key And Slot Repair, Transplant Method	R, W	High	E	C
3.5.1	Base Material Repair, Epoxy Method	R, W	High	A	C
3.5.2	Base Material Repair, Area Transplant Method	R, W	High	E	C
3.5.3	Base Material Repair, Edge Transplant Method	R, W	High	E	C
4.0	CONDUCTOR AND LAND PROCEDURES				
4.1.1	Lifted Conductor Repair, Epoxy Seal Method	R, F	Medium	I	C
4.1.2	Lifted Conductor Repair, Film Adhesive Method	R, F	High	I	C
4.2.1	Conductor Repair, Foil Jumper, Epoxy Method	R, F, C	Medium	A	D
4.2.2	Conductor Repair, Foil Jumper, Film Adhesive Method	R, F, C	High	A	C
4.2.3	Conductor Repair, Welding Method	R, F, C	High	A	C
4.2.4	Conductor Repair, Surface Wire Method	R, F, C	Medium	I	C
4.2.5	Conductor Repair, Through Board Wire Method	R	Medium	A	C
4.2.6	Conductor Repair, Inner Layer Method	R, F	High	E	D
4.3.1	Circuit Cut, Surface Circuits	R, F	High	A	D
4.3.2	Circuit Cut, Inner Layer Circuits	R, F	High	A	D
4.3.3	Deleting Inner Layer Connection At A Plated Hole, Drill Through	R, F	High	A	D
4.3.4	Deleting Inner Layer Connection At A Plated Hole, Spoke Cut	R, F	High	A	D

© 1997 CIRCUIT TECHNOLOGY CENTER, INC disclaims all liability associated with the use of this information.

CIRCUIT TECHNOLOGY CENTER, INC. , 45 Research Drive, Haverhill, MA 01832-1293 USA

Phone: 978.374.5000 ■ Fax: 978.372.5700 ■ E-Mail: info@circuitnet.com ■ Website: http://www.circuitnet.com

4.4.1	Lifted Land Repair, Epoxy Method	R, F	Medium	A	C
4.4.2	Lifted Land Repair, Film Adhesive Method	R, F	Medium	A	C
4.5.1	Land Repair, Epoxy Method	R, F	Medium	A	C
4.5.2	Land Repair, Film Adhesive Method	R, F	High	A	C
4.6.1	Edge Contact Repair, Epoxy Method	R, F, W, C	Medium	A	C
4.6.2	Edge Contact Repair, Film Adhesive Method	R, F, W, C	High	A	C
4.6.3	Edge Contact Repair, Plating Method	R, F, W, C	High	A	D
4.7.1	Surface Mount Pad Repair, Epoxy Method	R, F, C	Medium	A	D
4.7.2	Surface Mount Pad Repair, Film Adhesive Method	R, F, C	High	A	C
5.0	PLATED HOLE PROCEDURES				
5.1	Plated Hole Repair, No Inner Layer Connection	R, F, W, C	High	I	C
5.2	Plated Hole Repair, Double Wall Method	R, F, W, C	Medium	A	D
5.3	Plated Hole Repair, Inner Layer Connection	R	Medium	E	C
6.0	JUMPER WIRE PROCEDURES				
6.1	Jumper Wire Basics	R, F, W, C	N/A	I	C
6.2	Jumper Wires, Through Hole Components	R, F, W, C	N/A	I	C
6.3	Jumper Wires, Chip Components, Pads and Conductors	R, F, W, C	N/A	I	C
6.4	Jumper Wires, J Lead Components	R, F, W, C	N/A	I	C
6.5	Jumper Wires, Gull Wing Components	R, F, W, C	N/A	I	C
7.0	SOLDERING PROCEDURES				
7.1.1	Soldering Basics	R, F, W, C	N/A	I	C
7.1.2	Preparation For Soldering And Component Removal	R, F, W, C	N/A	I	C
7.1.3	Solder Joint Acceptance Criteria	R, F, W, C	N/A	I	C
7.2.1	Soldering Through Hole Components, Point To Point Method	R, F, W, C	High	I	C
7.2.2	Soldering Through Hole Components, Solder Fountain Method	R, F, W, C	High	E	C
7.3.1	Soldering SM Chip Components, Point To Point Method	R, F, W, C	High	I	C
7.3.2	Soldering SM Chip Components, Hot Gas Method	R, F, W, C	High	I	C
7.4.1	Soldering SM J Lead Components, Point To Point Method	R, F, W, C	High	I	C
7.4.2	Soldering SM J Lead Components, Continuous Flow Method	R, F, W, C	High	I	C
7.4.3	Soldering SM J Lead Components, Hot Gas Method	R, F, W, C	High	I	C
7.5.1	Soldering SM Gull Wing Components, Point To Point Method	R, F, W, C	High	I	C
7.5.2	Soldering SM Gull Wing Components, Continuous Flow Method	R, F, W, C	High	I	C
7.5.3	Soldering SM Gull Wing Components, Hot Gas Method	R, F, W, C	High	I	C
8.0	COMPONENT REMOVAL PROCEDURES				
8.1.1	Component Removal, Through Hole, Vacuum Method	R, F, W, C	High	I	C
8.1.2	Component Removal, Through Hole, Solder Fountain Method	R, F, W, C	High	E	C
8.2.1	Component Removal, SM Chip Components, Forked Tip Method	R, F, W, C	High	I	C
8.2.2	Component Removal, SM Chip Components, Hot Tweezer Method	R, F, W, C	High	I	C
8.3.1	Component Removal, SM J Lead Components, Conduction Method	R, F, W, C	High	A	C
8.3.2	Component Removal, SM J Lead Components, Hot Gas/Air Method	R, F, W, C	High	A	C
8.4.1	Component Removal, SM Gull Wing Components Conduction Method	R, F, W, C	High	A	C
8.4.2	Component Removal, SM Gull Wing Components Hot Gas/Air Method	R, F, W, C	High	A	C

1.0 FOREWORD

1.1 Introduction

PC boards are more complex today than ever before, but despite how severely damaged they may be, they can be repaired. Indeed the high value of many PC boards demands that they be repaired. Even less expensive assemblies require repair because just-in-time manufacturing and tightly controlled production runs leave little room for shortage.

Just a few years ago, PC boards were much simpler and repairs were relatively easy. Today's PC boards have fine pitch components, ball grid arrays and fine line circuits making them a challenge to repair. Yet, we're driven by simple economics and must repair damaged PC boards whenever possible. This manual is designed to help you repair and ship good, reliable PC boards that might otherwise be consigned to scrap.

Because of its high demands, PC board repair has been accurately compared to surgery. Whether repairing surface mount pads or repairing damaged internal circuitry, the technical knowledge and manual skills needed for high reliability repair and rework are indeed demanding. Since today's repair procedures are more sophisticated than ever before, you need a comprehensive guidebook.

The repair specialists at Circuit Technology Center, Inc. have used this guidebook to repair thousands of PC boards. Circuit Technology Center, Inc. is the world's leading specialist in PC board repair and modification and the procedures described herein are the same procedures they use to repair and modify PC boards. They have been repairing PC boards for over 15 years for companies including Digital Equipment Corporation, IBM, Hewlett Packard, Siemens, Compaq Computer, AT&T, Allied Signal Aerospace and hundreds of other commercial and military manufacturers.

Damaged PC boards may be compared to patients in a hospital. Some will need a stitch or two while others will need open heart surgery. To expect a reliable outcome, each repair project must follow proven and well established procedures. This guidebook covers the repair and rework of both surface mount and through hole PC boards and assemblies. Not only will this guidebook give you the details for most PC board repair procedures, but it will also explain why certain procedures are important and answer many questions that you're bound to have.

1.2 Purpose

This guidebook includes procedures for modifying, reworking and repairing printed boards and printed board assemblies. It complies with standards set by the Institute for Interconnecting and Packaging Electronic Circuits (IPC), in Northbrook IL. The main IPC documents to refer to when using this guidebook include:

J-STD-001	Requirements for Soldered Electrical and Electronic Assemblies
IPC-A-600	Acceptability of Printed Boards
IPC-A-610	Acceptability of Electronic Assemblies
IPC-R-700	Modification, Rework and Repair of Printed Boards and Assemblies.

Revision levels for each procedure are recorded in the header section. A complete log of engineering changes is maintained at Circuit Technology Center, Inc..

1.3 Classes of Product

Three Classes of Products are referred to in this guidebook.

1. Class 1 General Electronic Products
Includes consumer products, some computer products and computer peripherals, and hardware suitable for applications where the major requirement is the function of the completed assembly.
2. Class 2 Dedicated Service Electronic Products
Includes communications equipment, sophisticated business machines, and instruments where high performance and extended life is required, and for which uninterrupted service is desired but not critical. Typically, the end use environment would not cause failures.
3. Class 3 High Performance Electronic Products
Includes equipment for commercial and military products where continued performance or performance-on-demand is critical. Equipment downtime cannot be tolerated, end-use environment may be uncommonly harsh, and the equipment must function where required, such as life support and critical weapons systems.

1.4 Printed Board Types

Four Printed Board Types are referred to in this guidebook.

R - Rigid Printed Boards and Assemblies

A printed board or assembly using rigid base materials only. These may be single sided, double sided or multilayered.

F - Flexible Printed Boards and Assemblies

A printed board or assembly using flexible or a combination of rigid and flexible materials only. May be partially provided with electrically nonfunctional stiffeners and/or cover lay. These may be single sided, double sided or multilayered.

W - Discrete Wiring Boards and Assemblies

A printed board/assembly using a wire technique to obtain electrical interconnections.

C - Ceramic Boards and Assemblies

A printed board or assembly using ceramic as the base material with interconnections separated by dielectric.

1.5 Conformance Level

Conformance Level indicates how closely the repaired or reworked product will be to the original specifications. The Conformance Level listed for each procedure should be used as a guide only.

Conformance Levels include the following:

High Most closely duplicates the physical characteristics of the original and most probably complies with all the functional, environmental and serviceability factors.

Medium Some variance with the physical character of the original and most likely varies with some of the functional, environmental and serviceability factors.

Low Significant variance with the physical character of the original and may vary with many of the electrical, functional, environmental and serviceability factors.

Class 3 Products must use procedures rated High unless it can be demonstrated that a lower level procedure will not adversely affect the product's functional characteristics.

Class 2 and 1 Products should use procedures rated High for assured safety and dependability but Medium or Low Level procedures can be used if it has been determined that they are suitable for the specific product's functional characteristics.

Procedures in this manual are given a "Conformance Level" rating which is described in the following table.

**Table 1
Conformance Level**

Functional Consideration	Conformance Level		
	High	Medium	Low
Electrical - Resistance	Yes	Verify	No
Electrical - Inductance	Yes	Verify	No
Electrical - Capacitance	Yes	Verify	No
Electrical - Cross Talk	Yes	Verify	No
Electrical - High Speed Frequency	Yes	Verify	No
Environmental - Shock	Yes	Verify	No
Environmental - Vibration	Yes	Verify	No
Environmental - Humidity	Verify	Verify	Verify
Environmental - Temperature	Yes	Yes	Yes
Environmental - Altitude	Verify	Verify	Verify
Environmental - Bacteria	Yes	Verify	Verify
Environmental - Fungus	Yes	Verify	Verify
Serviceability - Future Repair or Mod.	No	Yes	Yes

No Procedure may not comply with functional consideration.

Verify Procedure should comply with functional consideration but should be tested to verify.

Yes Procedure will normally comply with functional consideration.

1.6 Skill Level

In the PC board manufacturing and assembly environment, most processes are tightly controlled and one-directional. The technicians who run these processes have certain defined characteristics and training. As you look deeper into the repair operation, the first thing that becomes apparent is that an entirely different set of skills is needed. Repair skills are more specific. They require a higher degree of manual dexterity, patience, and a thorough understanding of the repair process. There are more steps involved in any single repair operation than the typical assembly technician would be confronted with. It becomes a

personnel issue as well as a training one. You must not only have the proper training program, but the right people.

Repair personnel can't be part-timers and repair PC boards only one day a week or on a rotational basis with other duties. They should be dedicated to the repair operation and do nothing but repair. For challenging procedures to be done reliably, they must be done repeatedly. Furthermore, some repair skills are so specific that they should be limited to certain individuals who demonstrate an affinity for the job, rather than attempting to train a general number of persons to do the same difficult task.

Considerable supervision is required during the basic phase of the training operation, with lots of individual help and attention. The key is not to attempt to move people too fast on the road to proficiency. It's a step-by-step approach. Regardless of who provides the training, you will find that the greatest cost and investment is in personnel. Personnel are key to the success of the whole operation. Repair skills training is available from Circuit Technology Center, Inc..

Three Skill Levels are referred to in this guidebook. The Skill Level recommended should be used as a guide only.

I - Intermediate - Technician with skills in basic soldering and component rework but inexperienced in general repair/rework procedures.

A - Advanced - Technician with soldering and component rework skills and exposure to most repair/rework procedures but lacking extensive experience.

E - Expert - Technician with advanced soldering and component rework skills and extensive experience in most repair/rework procedures.

1.7 Tools and Materials

Repair is and may always be a highly labor intensive operation relying more on individual operator skills than automation. Despite the availability of very good tools for repair, many in-house repair operations are poorly equipped. Here are a few guidelines for the basic equipment needed in an up-to-date repair operation.

1. Ergonomic Workstation

Good repair work can't be done at an old workbench or makeshift setup. Performing PC board repair requires a high degree of concentration and dexterity. A proper workstation that is ESD grounded with proper lighting, outlets, and comfort is therefore essential. When possible, commonly used systems can be bolted to the work surface to improve efficiency.

2. High Quality Stereo Microscope

Precision repair cannot be done without a microscope of this type available to the repair operation 100% of the time. Limited access will not do since it must be used constantly. Use of video cameras and monitors, although they may be fine for inspection or training, should be avoided. They cannot provide the clarity that quality optics offer. Also, the microscope needs a good light. Halogen, or fiber optic lighting systems with flexible goosenecks to direct the light are the best for this application.

3. Soldering

Precision soldering is vital to modern repair operations. Repair technicians can't get by with the traditional soldering tools that were commonly used as recently as a few years ago. They need the very best soldering irons that are highly controlled, ergonomically designed and feature a wide assortment of small tips.

4. Component Removal Tools

Today's expanding variety of large and small components require an array of special use tools and methods for safe, efficient component removal. These tools generally use either conductive heating (by contact), convective heating (by hot gas) or infrared heating (by focused infrared lamps). Each method has its own advantages and disadvantages depending on the particular application.

5. Preheating Station

When possible, you should preheat the entire PC board before SMT component removal. Preheat minimizes thermal shock due to localized heating in the rework area, and speeds up the rework process. Most facilities have a curing/drying oven, but a preheating station for maintaining heat in addition to the oven is often necessary. A hotplate-style preheater or infrared heater will maintain the temperature of the board after it is taken out of the oven, or can heat the board up from ambient temperature.

6. Micro Drilling and Grinding Tool

Bulky, hand-held drilling and grinding tools that have both the motor and power supply contained within the handpiece are difficult to manipulate for the kind of detailed work that is necessary in repair. The type needed is preferably a lightweight, high quality, dental style drilling tool.

7. Precision Drilling System

Repair and rework projects often require the need to make precise holes, slots, grooves etc. Precision, accurate depth control and high speed are a must. The ideal system should have a base plate to pin PC boards in place and an optional microscope attachment.

8. Replacement Circuits and Pads

Circuits and surface mount pads can be replaced using liquid epoxy, but liquid epoxy can be messy and unreliable when replacing fine pitch pads. Pads are available with a dry film adhesive on the back. These replacement pads and circuits are heat-bonded to the board surface, and are available in any pattern that you might need.

9. Gold Contact Plating System

Plating gold edge contacts or any metal surface is a serious business. The chemicals used are hazardous and must be handled properly. The power applied to the plating surfaces must be controlled accurately to expect reliable results. A good plating systems should include the following: a DC power supply with voltage and current meters, plating anodes sized for gold edge contact plating, a solution tray to collect the solution runoff, a support for the PC board and a tray to hold and store the various chemicals safely.

10. Epoxy Kits and Coloring Agents

For many repair operations you need high strength, high temperature epoxies. You should select a two-part epoxy because they offer the high strength, thermal resistance and durability that one-part and quick-setting epoxies do not have. It is also important to have masks or coloring agents so that you can restore the cosmetic appearance of the board. It is best to cure the epoxies in an oven if possible.

11. Eyelets and Eyelet Press

Solder plated copper eyelets and an eyelet press to repair damaged plated through holes is generally required.

1.8 How To Set Up An In-House PC Board Repair Department

It's a fact that far more printed circuit assemblies are damaged during the manufacturing process than they are in the field. And even though PC boards are more complex today than ever before, they are still repairable. Ten years ago boards were much simpler, and repairs were easy; but the assemblies also cost a great deal less. Today's printed circuit manufacturers and assemblers are driven by simple economics. They must repair damaged circuit boards. The primary question is whether to develop and maintain a full repair department in-house, or to contract the repair out. Which choice makes the most sense?

Repair encompasses much more than simply rework, i.e. removing/reattaching components. You must be prepared to make a real commitment in several key areas if you plan to complete repair work in-house. If not, you are better off contracting the work out to a reputable repair facility. In reality, more damage can be done to a board from a botched repair than from most other causes. Aside from soldering and desoldering, other aspects of repair can include replacing damaged circuits, gold contacts, and SMT pads; re-plating solder-contaminated gold contacts, repairing burns or physical damage to the laminate, repair of through-holes, and more. Both contract manufacturers and OEMs will benefit from establishing a good in-house repair operation.

Five Keys to Reliability

There are five basic requirements needed for successful implementation of a high quality PC board repair department:

1. Documented Standards
2. Documented Procedures
3. Comprehensive training
4. Modern, Up-To-Date Equipment
5. Highly Skilled Technicians

1. Documented Standards

The key starting point, of course, is a good set of documented standards. Standards will establish which types of defects are acceptable as is, and which are not. Although most major manufacturers have their own set of acceptance standards, the small manufacturer can obtain commercially-available guidelines, in particular from the IPC. Specific documents include IPC A-600 and A-610. A good working knowledge of these standards can prevent unnecessary repair.

2. Documented Procedures

Every repair operation, whether it be replacing a pad or re-plating a gold contact, requires a specific set of procedures. The goal of this book is to provide you with a detailed

explanation of each procedure. If you need more information, an excellent additional reference source is the IPC's publication IPC-R-700. This IPC publication, along with this Guidebook, should be an integral part of your repair department and can serve as a tool for training repair personnel. To obtain copies of these publications, contact the Institute for Interconnecting and Packaging Electronic Circuits (IPC) in Northbrook, IL. Copies can also be obtained from Circuit Technology Center, Inc..

Once you know what can be repaired and have the necessary guidance to proceed, the next step is completing the repair, and that requires qualified personnel. Of course, even the most highly skilled technicians require training if they are to perform their best.

3. Comprehensive Training

Repair personnel can't be part-timers and repair only one day a week or on a rotational basis with other duties. They should be dedicated exclusively to the repair operation. The reason for this is to develop a high level of skill and maintain it through repetition. For many challenging aspects of repair to be done reliably, they must be done repeatedly, such as the replacement of fine-pitch surface mount pads. Furthermore, some repair skills are so specific that they should be limited to certain individuals who demonstrate an affinity for the job, rather than attempting to train a general number of persons to do the same difficult task.

Considerable supervision is required during the basic phase of the training operation, with lots of individual help and attention. The key is not to attempt to move people too fast on the road to proficiency. It's a step-by-step approach. Other companies may do it differently, but this is our method. Regardless of who provides the training, you will find that the greatest cost and investment is in personnel. Personnel are key to the success of the whole operation. Equipment costs are actually quite low in comparison. Why?

4. Modern, Up-To-Date Equipment

Repair is and may always be a highly labor intensive operation relying more on individual operator skills than automation. Despite the availability of very good tools for repair, many in-house repair operations are poorly equipped.

5. Highly Skilled Technicians

In the PC board manufacturing and assembly environment, most processes are tightly controlled and one-directional. The technicians who run these processes have certain defined characteristics and training. As you look deeper into the repair operation, the first thing that becomes apparent is that an entirely different set of skills are needed by repair personnel compared to assembly personnel. Repair skills are more specific. They require a higher degree of manual dexterity, patience, and a thorough understanding of the repair process. There are more steps involved in any single repair operation than the typical assembly technician would be confronted with. It becomes a personnel issue as well as a training one. You must not only have the proper training program, but the right people.

OUTLINE

This procedure covers the proper methods for handling PC boards.

REFERENCES

- 1.0 Foreword
- IPC-A-600 Acceptability of Printed Boards
- IPC-A-610 Acceptability of Electronic Assemblies

Electrostatic Discharge (ESD)

Certain components used in electronic assemblies are sensitive to static electricity and can be damaged by its discharge. Static charges are created when non-conductive materials are separated, such as when plastic bags are picked up or opened, when friction occurs between articles of synthetic clothing, when plastic tapes are dispensed and many other causes.

Destructive static charges are induced on nearby conductors, such as human skin, and delivered in the form of sparks passing between conductors, such as when the surface of printed board assembly is touched by a person having a static charge potential. If touched at the right solder joint or conductive pattern, the PC board assembly can be damaged as the discharge passes through the conductive pattern to a static sensitive component. It is important to note that usually the static damage level for components cannot be felt by humans. (Less than 3,000 volts.)

Electrical Overstress (EOS)

Electrical overstress damage can be caused by generation of unwanted energy; such as spikes, occurring within soldering irons, solder extractors, testing instruments and other electrically operated equipment. This equipment must be designed as to prevent unwanted electrical discharges.

ESD/EOS Safe Work Areas

The purpose of an ESD/EOS safe work area is to prevent damage to sensitive components from spikes and static discharges. These areas must be designed and maintained to prevent ESD/EOS damage.

Handling and Storage Methods

1. PC board assemblies must always be handled at properly designated work areas.
2. Designated work areas must be checked periodically to ensure their continued safety from ESD. Areas of main concern include:
 - A. Proper grounding methods.
 - B. Static dissipation of work surfaces.
 - C. Static dissipation of floor surfaces.
 - D. Operation of ion blowers and ion air guns.
3. Designated work areas must be kept free of static generating materials such as Styrofoam, vinyl, plastic, fabrics or any other static generating materials.

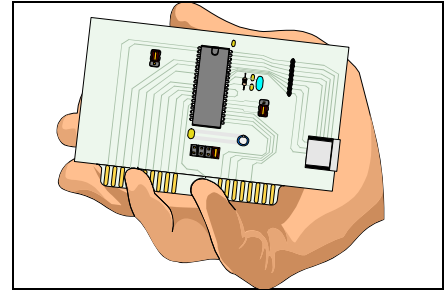

Figure 1: Always handle PC boards by the edges.

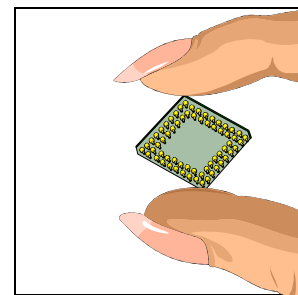

Figure 2: Handle components by edges to prevent contaminating leads with skin oil.

4. Work areas must be kept clean and neat. To prevent contamination of PC board assemblies, there must be no eating or smoking in the work area.
5. When not being worked on, sensitive components and PC boards must be enclosed in shielded bags or boxes.
6. Whenever handling a PC board assembly the operator must be properly grounded by one of the following:
 - A. Wearing a wrist strap connected to earth ground.
 - B. Wearing 2 heel grounders and have both feet on a static dissipative floor surface.
7. PC board assemblies should be handled by the edges. Avoid touching the circuits or components. (See Figure 1).
8. Components should be handled by the edges when possible. Avoid touching the component leads. (See Figure 2).
9. Hand creams and lotions containing silicone must not be used since they can cause solderability and epoxy adhesion problems. Lotions specifically formulated to prevent contamination of PC boards are available.
10. Stacking of PC boards and assemblies should be avoided to prevent physical damage. Special racks and trays are provided for handling.

OUTLINE

Surface contaminants can significantly effect soldering, bonding, coating and the electrical characteristics of printed board and assemblies. This procedure outlines the cleaning methods for PC boards and assemblies.

REFERENCES

- 1.0 Foreword
- 2.1 Handling Electronic Assemblies

NASCWPNS Final report for NON-ODS cleaning of electronics and avionics report of October 1, 1995.

LIMITATIONS

1. The ability of solvent based cleaning solutions to remove flux residue containing polyglycols should be assessed since not all solvent based cleaning solutions will remove polyglycols.
2. A deionized water rinse should follow IPA/DI cleaning except that a water rinse for double sided PC boards with plated through holes may not be required.
3. Potable (drinking) water should not be used as a final rinse due to the potential of contaminating the PC board assembly with chlorine, fluorine and halides.
4. When automated cleaning is used for assemblies that have been conformally coated, it is important that the cleaning process is compatible with the type of coating used and with any unsealed components. The coating should be checked to ensure that the coating will not be degraded by the cleaning process.

TOOLS & MATERIALS

Black Light
Brush
Cleaner, Aqueous or Semi-Aqueous
Containers
Gloves
Isopropyl Alcohol (IPA)
Oven
Wipes

PROCEDURE

CAUTION

Use clean gloves during this entire operation.

NOTE

To reduce solvent volumes, mixtures of IPA with water and IPA with solvent are available in pressurized containers. The propellants are HFC's. These containers may be fitted with a bristle brush spray attachments for additional cleaning action.

1. Clean the board in an Aqueous or Semi-Aqueous cleaner, or pour approximately 10 ml per 4 square inches of effected area.
2. Scrub the board vigorously with a continually wet soft bristle brush for 10 seconds.
3. Rinse the area with 10 ml per 4 square inches of clean Isopropyl Alcohol to effectively remove all potentially harmful residues.
4. Handle the board by the edges and blot the excess Isopropyl Alcohol with clean, lint free cloth.
5. Examine board visually for cleanliness. The use of a black light will help detect contaminants that will fluoresce.
6. Dry boards in oven, if desired.
7. If the boards or assemblies are to be stored before use or coating, remove them from the oven and allow to cool until they can be handled. Place the boards or assemblies into self sealing bags with packages of desiccant.

EVALUATION

1. Visually examine and test for cleanliness using IPC-TM-650, test method 2.3.25 or 2.3.26

OUTLINE

This procedure covers the techniques for identifying various coatings so that the appropriate coating removal method can be selected.

REFERENCES

- 1.0 Foreword
- 2.1 Handling Electronic Assemblies
- 2.2 Cleaning
- 2.5 Baking And Preheating
- 2.7 Epoxy Mixing and Handling

TOOLS & MATERIALS

Brush
Cleaner
Cleaner\Solvent
Cutting Disk
Foam Swab
Heated Blade
Micro-Drill System
Precision Knife
Thermal Parting Tool Wipes Wood Stick

PROCEDURE

To determine the appropriate coating removal procedure the coating must first be identified. During original manufacture the specific coating is usually known. Consequently, the coating removal methods can usually be specified and based on the known coatings being used.

When identification of the coating is not available, simple observation and testing will help identify the coating characteristics so that the proper removal procedure can be specified.

NOTE

The generic or commercial identification of the coating material is not necessary to accomplish coating removal.

1. Hardness

Penetration test in a non-critical area to determine relative hardness. The harder the coating the more suitable to pure abrasive techniques. The softer and gummier the coatings the more suitable to the brushing removal procedures.

CAUTION

Abrasion operations can generate electrostatic charges.

2. Transparency

Obviously transparent coatings are usually more suitable for removal than the opaque type. Removal methods used with opaque coatings must be far more controllable and less sensitive to damaging the covered components and printed board surfaces and are usually slower.

3. Solubility

Test the coating for solubility characteristics in a non-critical area with trichloroethane, xylene or other solvents with low toxicity and mild activity.

CAUTION

Printed board assemblies should not be immersed in harsh solvents.

4. Thermal Removal

Use a thermal parting device with controlled heating and without a cutting edge to determine whether the coating can be thermally removed. Start with a low temperature, approx. 100° C (210° F), and increase the temperature until the coating is removed. If the coating flows or gums up, you are too hot or the coating is not suitable for thermal removal.

CAUTION

Do not exceed the maximum component storage temperature or other limitation.

5. Stripability

Carefully slit the coating with a sharp blade in a non-critical area and try to peel back from the surface to determine if this method is feasible. Due to the adhesion required of coating materials, strippable techniques without chemical aids is usually very limited.

6. Thickness

Determine if the coating is thick or thin by visual means. Thin coatings show sharp component outlines and no fillets while thick coatings reduce sharp component outlines and show generous fillets at points of component or lead intersection with the printed board. Thick coatings usually require two step removal methods to prevent surface damage to the board. First reduce the thick coating down to a thin one and then use pure abrasion methods to reach the surface of the board.

The specific coating to be removed may have one or more of these characteristics and consequently the removal method selected should consider the composite characteristics.

See Table 1 for Conformal Coating Identification.

See Table 2 for Conformal Coating Removal Methods.

See Table 3 for Conformal Coating Characteristics.

Table 1
Conformal Coating Identification

Test	Yes	No
1. Does the coating feel soft, rubbery or spongy?	2	3
2. Does the coating have a noticeable reaction to heat?	Poly-urethane	4
3. Is there a reaction to alcohol?	Acrylic	5
4. Is the coating thick and have a dull surface?	Silicone Thick	Silicone Thin
5. Does the coating have a noticeable reaction to heat?	6	Para-xylyene
6. Does the reaction form white powder?	Epoxy	Poly-urethane

Table 2
Conformal Coating Removal Methods

Conformal Coating	Removal Method				
	2.3.2 Solvent Method	2.3.3 Peeling Method	2.3.4 Thermal Method	2.3.5 Grinding Scraping Method	2.3.6 Micro Blasting Method
Para-xylyene			1	2	3
Epoxy			1	2	3
Acrylic	1		2	3	4
Poly-urethane	3		1	2	4
Silicone Thin	1		2	3	4
Silicone Thick		1		2	

NOTE

The preferred order for applying individual removal methods to specific coatings is numerically indicated. These removal methods are listed in ascending order.

**Table 3
Conformal Coating Characteristics**

Characteristics	Conformal Coating Type				
	Epoxy	Acrylic	Polyur-ethane	Silicone Resin	Para-xylylene
Hard	x		x		x
Medium Hard		x	x		
Soft			x	x	
Heat Reaction	x	x	x		
Surface Bond - Very Strong	x			x	x
Surface Bond - Strong		x		x	
Surface Bond - Medium			x	x	
Surface Bond - Light				x	
Solvent Reaction		x			
Smooth Surface	x	x	x	x	x
Lumpy Surface					
Nonporous Surface	x	x	x		x
Glossy Surface	x	x	x		
Semiglossy Surface	x			x	
Dull Surface					x
Rubbery Surface				x	
Brittle	x	x			
Chips	x	x			
Peels/ Flakes		x	x		x
Stretches			x	x	
Scratch, Dent, Bend, Tear			x	x	x

OUTLINE

This procedure uses a solvent to remove surface coatings. This procedure can be used for spot or overall coating removal of conformal coatings or solder resists.

Approved solvents may be used to remove specific soluble type coatings on a spot basis by brushing or swabbing the local area with the controlled application of solvent until the area is free of the coating material.

If warranted, all the soluble type coating can be removed by immersing and brushing the entire printed board or printed board assembly.

To determine the appropriate coating removal procedure the coating must first be identified. Refer to procedure number 2.3.1.

NOTE

Coating removal may require the use of one or more methods.

CAUTION

Determine, on a module by module basis, the hazards to parts, etc., by short term immersion in the removal solvents. If chloride based or other harsh solvents are used, extreme care must be exercised to prevent damage to base material, component parts, plated-through holes, and solder joints. Some solvent coating removal methods can cause expansion or swelling of the base material which can degrade the printed board or printed board assembly. Under no circumstances should these solvents be used except in a closely controlled process. It is recommended that the printed board or printed board assembly be inspected to ensure that no damage has occurred.

Before using any solvent refer to Material Safety Data Sheets.

REFERENCES

- 1.0 Foreword
- 2.1 Handling Electronic Assemblies
- 2.2 Cleaning
- 2.3.1 Coating Removal, Identification Of Coatings
- 2.4.1 Coating Replacement, Solder Mask
- 2.4.2 Coating Replacement, Conformal Coatings/Encapsulants

TOOLS & MATERIALS

- Brush
- Foam Swab
- Precision Knife
- Suitable Solvent
- Tape, High Temperature
- Thermal Parting Tool
- Wood Stick

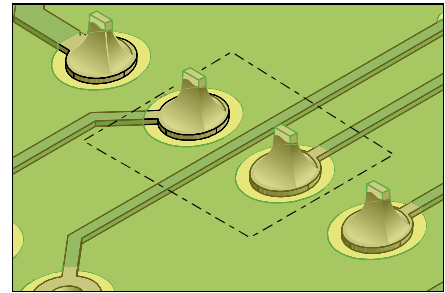

Coating Removal Required At Outlined Area

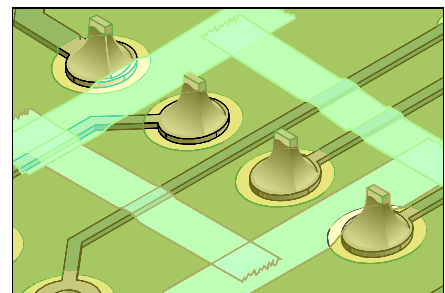

Figure 1: Apply High Temperature Tape to outline area for coating removal.

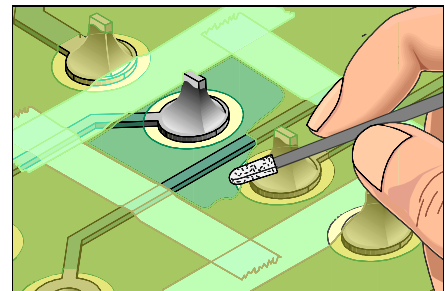

Figure 2: Apply solvent with a foam swab to remove coating.

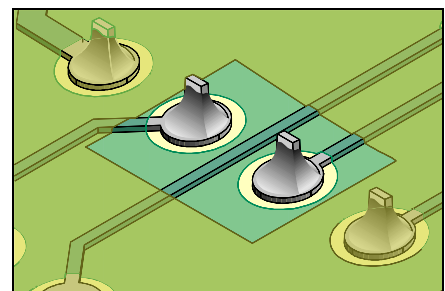

Figure 3: Removal complete.

PROCEDURE - LOCAL SPOT REMOVAL

1. Apply High Temperature Tape to outline the area where the coating needs to be removed. (See Figure 1).
2. Dip the end of a foam swab in stripping solution and apply a small amount to the coating to be removed. (See Figure 2)

NOTE

Since various substances may be used as coatings, the time required for a given coating to dissolve or soften will vary. Reapply solvent several times as most solvents evaporate rapidly.

3. Rub the treated surface carefully with a brush or wood stick to dislodge the coating. A wedge shaped applicator tip, knife, or heated blade may be effective in removing some coatings, particularly polyurethanes.
4. Neutralize or clean the stripped area and dry.

PROCEDURE - OVERALL REMOVAL

1. A single step for removal of all the coating may be completed by providing a continuous flow of solvent.

Alternately, process the board in a series of tanks containing mild solvent, starting with a high contamination tank and progressing sequentially to a final, fresh solvent tank.

EVALUATION

1. Visual examination or UV light may be used to verify complete removal of coating.

OUTLINE

This peeling removal method for coating can be used only under special circumstances. Normally this method is used to remove RTV silicone or other thick rubbery-like coating materials.

The coating material is removed using a dull knife or otherwise dull blade to slit the coating material and to peel it off the printed board or printed board assembly.

To determine the appropriate coating removal procedure the coating must first be identified. Refer to procedure number 2.3.1.

NOTE

This method is limited to coatings that are rubbery in nature to allow the coating material to be slit into small sections and peeled off the printed board assembly.

REFERENCES

- 1.0 Foreword
- 2.1 Handling Electronic Assemblies
- 2.2 Cleaning
- 2.3.1 Coating Removal, Identification Of Coatings
- 2.4.1 Coating Replacement, Solder Mask
- 2.4.2 Coating Replacement, Conformal Coatings/Encapsulants

TOOLS AND MATERIALS

- Heated Blade or Thermal Parting Tool
- Precision Knife
- Wood Stick

PROCEDURE

1. Slit and peel off the coating material with a dull knife or heated dull blade. (See Figure 1).
2. Repeat as needed until the required material is removed.

EVALUATION

1. Visual examination or UV light may be used to verify complete removal of coating

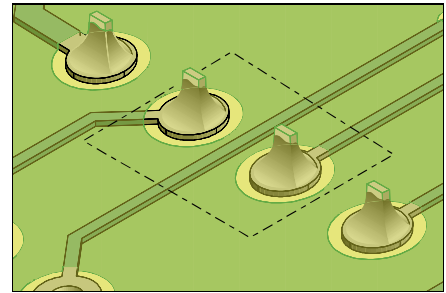

Coating Removal Required At Outlined Area

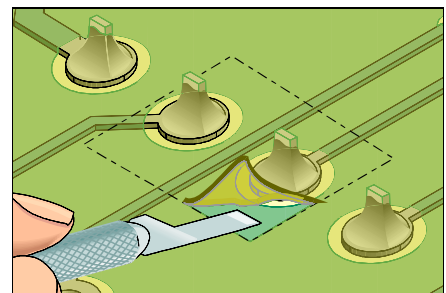

Figure 1: Slit and peel off coating using a knife or heated blade.

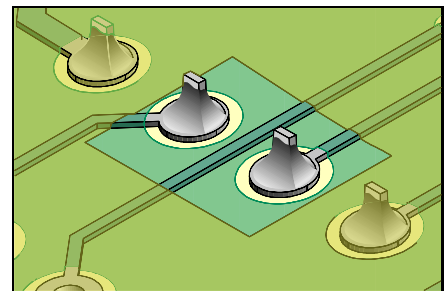

Figure 3: Removal complete.

OUTLINE

This coating removal procedure uses a controlled, low temperature, localized heating method for removing thick coatings by an overcuring or softening means.

Two methods are covered. The first method uses various shaped, temperature controlled tips, with dull edges to soften and remove the coating. The second method uses a localized controlled jet of hot air or inert gas to soften the coating material which is pushed away or removed by a non-marring tool. These methods do not burn or char either the coating or printed board.

CAUTION

Soldering irons should not be used for coating removal as their high operating temperatures will cause the coatings to char and possibly delaminate the printed board base material.

The use of thinned down soldering iron tips or soldering iron heated thin cutting blades are not recommended since they do not provide controlled heating and may present dangerous sharp edges to the workpiece surface.

To determine the appropriate coating removal procedure the coating must first be identified. Refer to procedure number 2.3.1.

REFERENCES

- 1.0 Foreword
- 2.1 Handling Electronic Assemblies
- 2.2 Cleaning
- 2.3.1 Coating Removal, Identification Of Coatings
- 2.4.1 Coating Replacement, Solder Mask
- 2.4.2 Coating Replacement, Conformal Coatings/Encapsulants

TOOLS AND MATERIALS

- Brush
- Cutter
- Heated Blade or Thermal Parting Tool
- Hot Air Tool
- Precision Knife
- Wood Stick

PROCEDURE - THERMAL PARTING METHOD

1. Select an appropriate thermal parting tip to suit the workpiece configuration. Set the nominal tip temperature, using the manufacturer's recommended procedure.
2. Apply the thermal parting tip to the coating, using a light pressure. The coating material will either soften or granulate. Polyurethanes will soften and epoxies will granulate. The tip temperature should be regulated to a point where it will effectively "break down" the coating without scorching or charring. (See Figure 1).

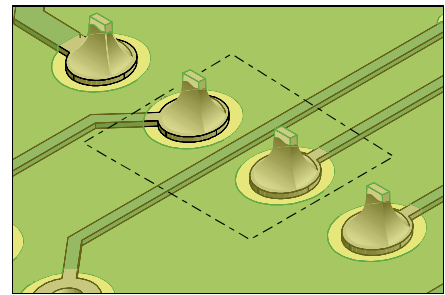

Coating Removal Required At Outlined Area

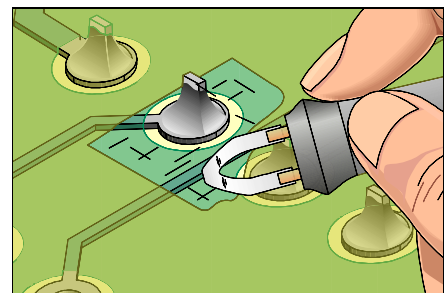

Figure 1: Lightly apply thermal tip to coating to soften or granulate the material.

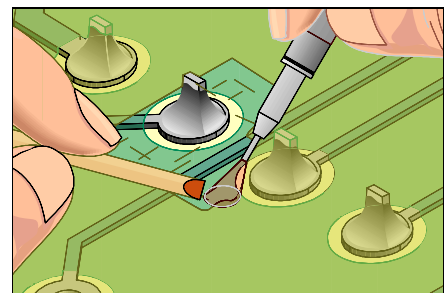

Figure 2: Apply hot air to the work area and use a wood stick to remove the overcured coating.

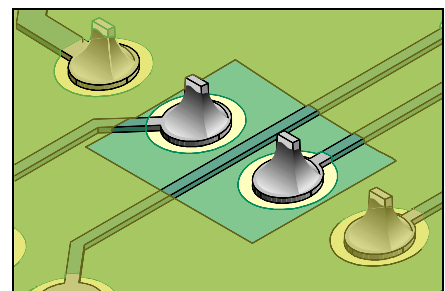

Figure 3: Removal complete.

3. Gradually reduce the coating thickness around the component body without contacting the board surface. Remove as much coating as possible from around component leads to allow easy removal of the leads.

Clip leads of component parts that are known to be faulty, thus permitting removal of the part body separately from leads and solder joints. Low pressure air or a brush should be used to remove the loosened coating.

4. Once sufficient coating has been removed, leaving only a small bonded joint between the part body and printed board, heat the component body with the thermal parting tool or hot air jet to weaken the bond beneath the component.
5. Lift the component body free of the printed board using small pliers.

NOTE

Twist the component prior to removal to shear any remaining epoxy bond to the printed board surface.

6. Once the component body has been removed from the board surface, the remaining coating material can be removed by additional thermal parting. The remaining leads and solder joints are then removed by appropriate solder extraction means.

PROCEDURE - HOT AIR METHOD

By control of the gas/air temperature, flow rates and jet shape, the hot air method can be applied to almost any workpiece configuration on both the component and solder side of the printed board without damage. Extremely delicate work can be handled in this manner while permitting direct observation of the heating action.

1. Set up the hot air tool per the manufacturer's instructions. Adjust flow rate and temperature to suit specific coating removal application.

CAUTION

Never set the gas/air temperature at a level that will cause scorching or charring of the coating material or reflow the solder connections.

2. Apply the heated air jet to work area. Apply light pressure using a wood stick or other non marring tool to remove the softened or overcured coating. All coating around individual leads, solder joints and component bodies can be removed in this manner. (See Fig. 2).
3. When the coating has been removed, use appropriate solder extraction method to remove components if needed.

EVALUATION

1. Visual examination or UV light may be used to verify complete removal of coating.

OUTLINE

This coating removal method uses various grinding and scraping tools, depending on the composition of the coating material. A knife or dental style scraper is normally used when a scraping method is desired. A hand held drill is normally used when a grinding technique is desired. A wide variety of rotary abrasive materials including ball mills may be required.

To determine the appropriate coating removal procedure the coating must first be identified. Refer to procedure number 2.3.1.

CAUTION

Abrasion operations can generate electrostatic charges.

REFERENCES

- 1.0 Foreword
- 2.1 Handling Electronic Assemblies
- 2.2 Cleaning
- 2.3.1 Coating Removal, Identification Of Coatings
- 2.4.1 Coating Replacement, Solder Mask
- 2.4.2 Coating Replacement, Conformal Coatings/Encapsulants

TOOLS AND MATERIALS

- Ball Mills
- Brush
- Cleaner
- Eraser Stick
- Micro-Drill System
- Microscope
- Precision Knife
- Rubberized Abrasives
- Scraper
- Wipes
- Wood Stick

PROCEDURE - SCRAPING

1. Clean the area.
2. Remove the damaged or unwanted coating or solder mask using the Precision Knife or Scraper. Hold the blade perpendicular to the coating and scrape from side to side until the desired material is removed. (See Figure 1).
3. Remove all loose material and clean the area.

PROCEDURE - GRINDING

1. Clean the area.

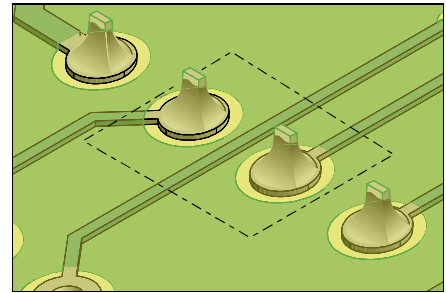

**Coating Removal Required
At Outlined Area**

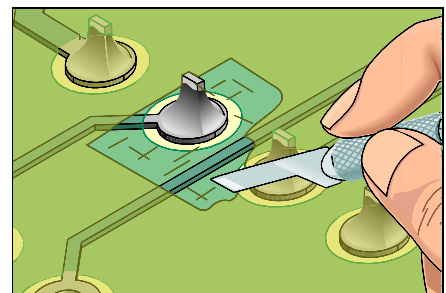

Figure 1: Scrape away damaged or unwanted coating with the Precision Knife or Scraper.

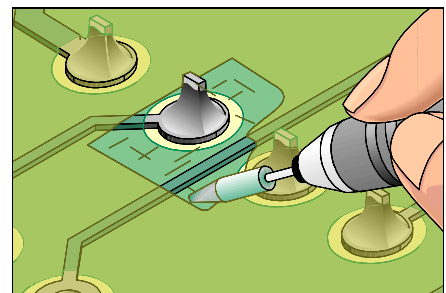

Figure 2: Rubberized abrasives are best used to remove thin, hard coatings.

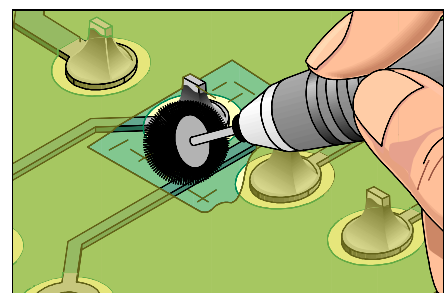

Figure 3: Rotary brushes are best used to remove soft coatings.

2. Insert an abrasive tip into the hand held drill. Abrade away the damaged or unwanted coating. Move the tool from side to side to prevent damage to the PC board surface. (See Figure 2).
3. Remove all loose material and clean the area.

NOTE

Rubberized abrasives of the proper grade and grit are ideally suited for removing thin hard coatings from flat surfaces but not for soft coatings since these would cause the abrasive to "load up" with coating material and become ineffective.

Rotary brushes are better suited than rubberized abrasives on contoured or irregular surfaces, such as soldered connections, etc., since the bristles will conform to surface irregularities while removing hard or soft coatings. (See Figure 3).

NOTE

The procedure for removing thick coatings is primarily to reduce their thickness to a thin coating and then to remove the remaining thin coating by the scraping method.

EVALUATION

1. Visual examination or UV light may be used to verify complete removal of coating

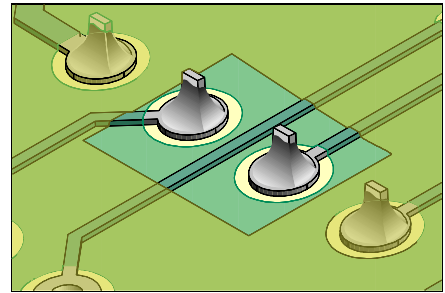

Figure 4: removal complete.

OUTLINE

This coating removal method uses a micro abrasive blasting system and a very fine soft abrasive powder. The powder is propelled through a small nozzle toward the area where the coating needs to be removed.

To determine the appropriate coating removal procedure the coating must first be identified. Refer to procedure number 2.3.1.

CAUTION

Micro blasting will generate substantial static charges. The work area should be flooded with ionized air and the PC board assembly should be grounded whenever possible.

REFERENCES

- 1.0 Foreword
- 2.1 Handling Electronic Assemblies
- 2.2 Cleaning
- 2.3.1 Coating Removal, Identification Of Coatings
- 2.4.1 Coating Replacement, Solder Mask
- 2.4.2 Coating Replacement, Conformal Coatings/Encapsulants

TOOLS AND MATERIALS

Abrasive Powder
Micro Blasting System
Masking Tape

PROCEDURE

1. Clean the area.
2. Select the appropriate abrasive blasting powder and nozzle size. Set the air pressure at the desired setting per equipment manufacturer's instructions.
3. Apply masking tape or other masking material to protect the PC board surface as needed. (See Figure 1). Masking materials can consist of tapes, curable liquid masks or reusable stencils.
4. If the PC board has static sensitive components, insert the entire PC board into a shielded bag. Only the area needing rework should be exposed. Ground the PC board to dissipate static charges.
5. Insert the PC board into the blasting chamber and blast away the damaged or unwanted coating\solder mask. Slowly move the nozzle along the area where the coating is to be removed. (See Figure 2).
6. Blow off the blasting dust and clean the area.

EVALUATION

1. Visual examination or UV light may be used to verify complete removal of coating.

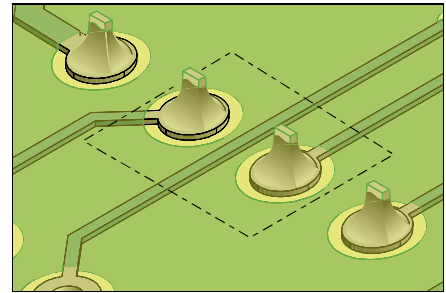

Coating Removal Required At Outlined Area

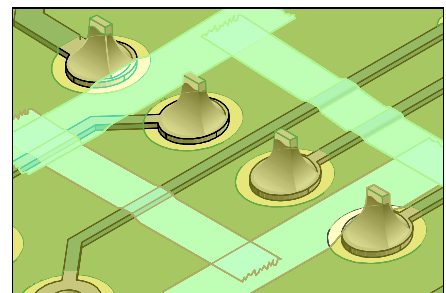

Figure 1: Apply High Temperature Tape to outline area for coating removal.

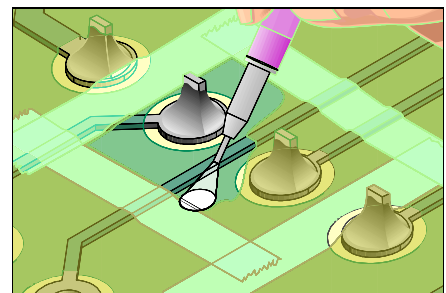

Figure 2: Remove coating using micro blasting system.

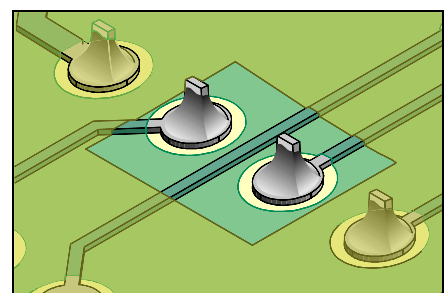

Figure 3: Removal complete.

OUTLINE

This method is used to replace solder mask or coatings on PC boards. Most replacement coatings can be applied by dipping, brushing or spraying.

REFERENCES

- 1.0 Foreword
- 2.1 Handling Electronic Assemblies
- 2.2 Cleaning
- 2.5 Baking and Preheating
- 2.7 Epoxy Mixing and Handling

TOOLS & MATERIALS

Brush
Cleaner
Color Agent
Epoxy
Foam Swab
Heat Lamp
Microscope
Oven
Wipes

PROCEDURE

1. Clean the area.
CAUTION
Surfaces to be coated must be thoroughly cleaned prior to coating to ensure adequate adhesion, minimized corrosion, and optimized electrical properties.
2. If needed, apply High Temperature tape to outline the area where the soldermask will be applied.
3. Mix the epoxy or replacement coating. If desired, add color agent to the mixed epoxy to match the PC board color.
4. Apply the replacement coating to the board surface as required. A brush or foam swab may be used to apply and spread the epoxy or replacement coating. (See Figure 1).
5. Cure the epoxy per Procedure 2.7 Epoxy Mixing and Handling.

CAUTION

Some components may be sensitive to high temperature.

EVALUATION

1. Visual examination for texture, color match, adhesion and coverage.
2. Electrical tests to conductors around the repaired area as applicable.

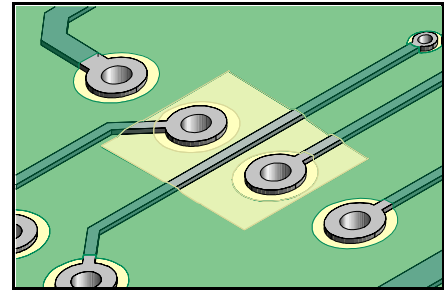

**Soldermask Required
At Outlined Area**

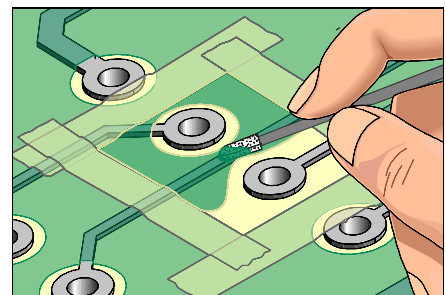

Figure 1: For large surfaces, apply the replacement coating with a foam swab to create a texture.

OUTLINE

This method is used to replace conformal coatings and encapsulants on PC boards.

REFERENCES

- 1.0 Foreword
- 2.1 Handling Electronic Assemblies
- 2.2 Cleaning
- 2.5 Baking and Preheating
- 2.7 Epoxy Mixing and Handling

TOOLS & MATERIALS

Brush
Color Agent
Cleaner
Epoxy
Foam Swab
Heat Lamp
Microscope
Oven
Wipes

PROCEDURE

1. Clean the area.

CAUTION

Surfaces to be coated must be thoroughly cleaned prior to coating to ensure adequate adhesion, minimized corrosion, and optimized electrical properties.

2. If needed, apply High Temperature Tape to outline the area where the coating will be applied.
3. If required, bake the PC board prior to the application of the replacement coating.
4. Mix the replacement coating.
5. Apply the replacement coating to the board surface as required. A brush or foam swab may be used to apply and spread the replacement coating. (See Figure 1).
6. Cure the epoxy per Procedure 2.7 Epoxy Mixing and Handling.

CAUTION

Some components may be sensitive to high temperature.

EVALUATION

1. Visual examination for texture, color match, adhesion and coverage.
2. Electrical tests to conductors around the repaired area as applicable.

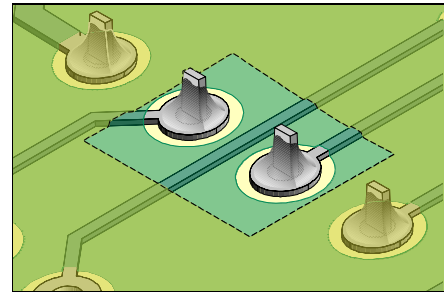

**Conformal Coating Required
At Outlined Area**

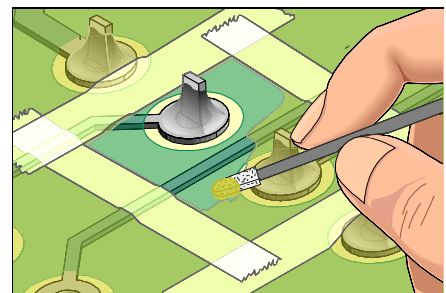

Figure 1: For large surfaces, apply the replacement coating with a foam swab to create a texture.

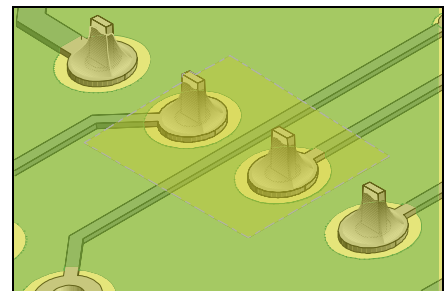

Figure 2: Coating complete.

OUTLINE

This procedure covers baking and preheating of printed boards and printed board assemblies to prepare the product for the subsequent operations. Included are steps for:

A. Baking

Baking is used to eliminate absorbed moisture. Whenever possible PC boards and PC Board assemblies should be baked prior to soldering, unsoldering and coating operation to prevent blistering, measling or other laminate degradation.

B. Preheating

Preheating is used to promote the adhesion of subsequent materials to the board surfaces and to raise the temperature of the PC board to allow soldering and unsoldering operations to be completed more quickly.

CAUTION

Baking and preheating procedures must be carefully selected to ensure that temperature and time cycles used do not degrade the product. Environmental conditions must also be carefully considered to ensure that vapors, gases, etc., generated during the heating process do not contaminate the product's surfaces.

CAUTION

To prevent fluxes or other contaminants from being baked onto the board surface, thoroughly clean the board or assembly prior to baking or preheating.

REFERENCES

- 1.0 Foreword
- 2.1 Handling Electronic Assemblies
- 2.2 Cleaning

TOOLS & MATERIALS

Cleaner
Oven
Wipes

OUTLINE

This method can be used to add, change or replace legend and markings on printed boards or printed board assemblies. This method uses epoxy ink and an ink stamp to place the legends on the printed board surface in much the same manner as taking a "finger print".

REFERENCES

- 1.0 Foreword
- 2.1 Handling Electronic Assemblies
- 2.2 Cleaning
- 2.5 Baking and Preheating
- 2.7 Epoxy Mixing and Handling

TOOLS & MATERIALS

- Cleaner
- Color Agent/Epoxy Ink
- Ink Plate
- Ink Roller
- Microscope
- Oven
- Peg Stamps
- Precision Knife
- Wipes

PROCEDURE

1. Clean the area.
2. Scrape off any remaining character or legend with the Precision Knife and clean the area.

CAUTION

Abrasion operations can generate electrostatic charges.

3. Select the appropriate characters from the peg stamp set or have a special stamp made up.
4. Mix the epoxy ink. White is the most common color. Spread a thin even coating of the epoxy ink on the ink plate or on a smooth surface.
5. Gently press the peg stamp into the epoxy coating to coat the character surface.
6. Gently press the peg stamp onto the desired location on the PC board surface. (See Figure 1).
7. Cure the epoxy ink per the manufacturer's instructions.

EVALUATION

1. Visual examination for proper characters, positioning and legibility.

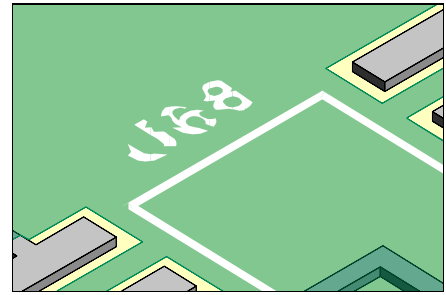

Damaged Legend

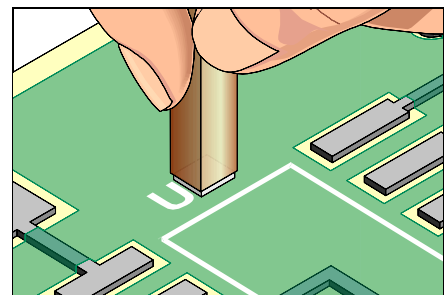

Figure 1: Apply legend using a peg stamp.

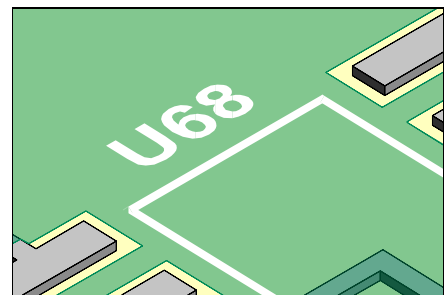

Figure 2: Completed legend repair.

OUTLINE

This method can be used to add, change or replace legend and markings on printed boards or printed board assemblies. This method uses epoxy ink and a pen to hand letter the legends on the printed board surface.

REFERENCES

- 1.0 Foreword
- 2.1 Handling Electronic Assemblies
- 2.2 Cleaning
- 2.5 Baking and Preheating
- 2.7 Epoxy Mixing and Handling

TOOLS & MATERIALS

- Cleaner
- Color Agent/Epoxy Ink
- Ink Pen
- Microscope
- Oven
- Precision Knife
- Wipes
- Wood Stick

PROCEDURE

1. Clean the area.
2. Scrape off any remaining character or legend with a knife and clean the area.

CAUTION

Abrasion operations can generate electrostatic charges.

3. Mix the epoxy ink. White is the most common color.
4. Sharpen a wood stick and dip the pointed end into the epoxy ink. Hand letter the legend or markings as needed.
5. Cure the epoxy ink per the manufacturer's instructions.

EVALUATION

1. Visual examination for proper characters, positioning and legibility.

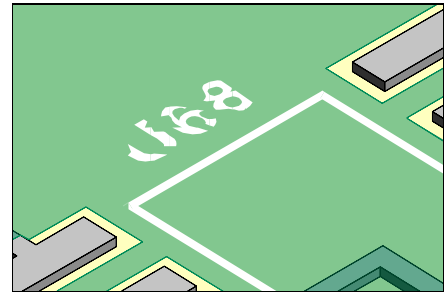

Damaged Legend

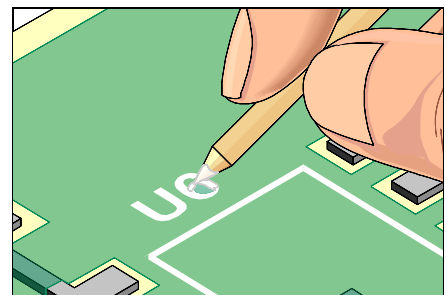

Figure 1: Apply legend using a wood stick dipped in epoxy ink.

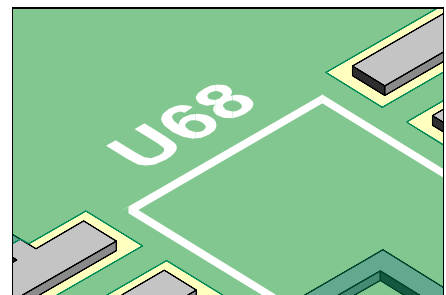

Figure 2: Completed legend repair.

OUTLINE

This method can be used to add, change or replace legend and markings on printed boards or printed board assemblies. This method uses epoxy ink and a brush or roller technique. A stencil is used to outline the characters.

REFERENCES

- 1.0 Foreword
- 2.1 Handling Electronic Assemblies
- 2.2 Cleaning
- 2.5 Baking and Preheating
- 2.7 Epoxy Mixing and Handling

TOOLS & MATERIALS

Cleaner
Color Agent/Epoxy Ink
Ink Roller
Ink Plate
Microscope
Oven
Precision Knife
Stencil
Wipes

PROCEDURE

1. Clean the area.
2. Scrape off any remaining character or legend with the Precision Knife and clean the area.

CAUTION

Abrasion operations can generate electrostatic charges.

3. Select the appropriate stencil or have a special stencil made up. (See Figure 1).
4. Mix the epoxy ink. White is the most common color. Spread a thin even coating of the epoxy ink on the ink plate or on a smooth surface.
5. Position the stencil on the PC board surface and hold in place firmly.
6. Roll or brush the ink onto the stencil. Do not smudge characters or apply excess ink.
7. Cure the epoxy ink per the manufacturer's instructions.

EVALUATION

1. Visual examination for proper characters, positioning and legibility.

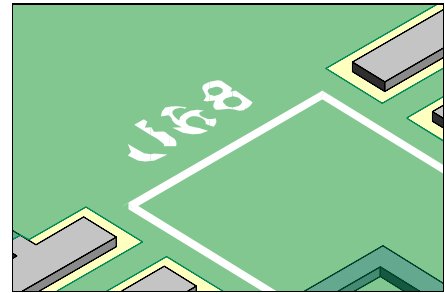

Damaged Legend

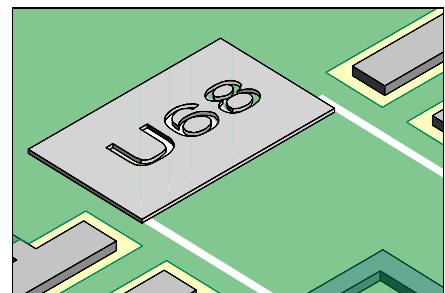

Figure 1: Replace legend using a stencil.

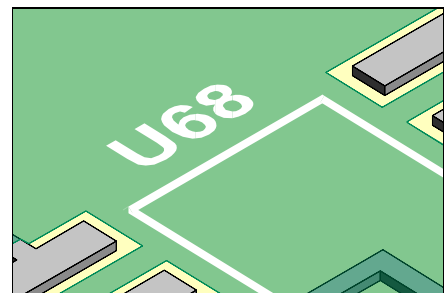

Figure 2: Completed legend repair.

OUTLINE

This procedure covers epoxy mixing and handling. The epoxy covered by this procedure has multiple uses including solder mask repair, base board repair, circuitry over-coating and delamination repair.

NOTE

For high strength or high temperature applications two part epoxies will generally have the best properties.

REFERENCES

- 1.0 Foreword
- 2.1 Handling Electronic Assemblies
- 2.2 Cleaning
- 2.5 Baking and Preheating

TOOLS AND MATERIALS

Cleaner
Color Agent
Epoxy
Foam Swab
Heat Lamp
Mixing Cup
Mixing Stick
Oven
Wipes

EP-01 Epoxy - Technical Information

Packaging	2 gram prepackaged containers
Color	Clear, transparent
Pot life	30 minutes
Cure cycle	24 hours at room temperature or 1 hour @ 165°F (74°C)
Viscosity (after mixing)	1900 cps @ 77°F (25°C)
Operating temperature range	-76°F to 284°F (-60°C to 140°C)
Hardness	88 Shore D
Dielectric strength	410 volts/mil

PC BOARD PREPARATION

The area where the epoxy is to be applied should be prepared prior to mixing the epoxy. This preparation may include preheating the affected area to improve absorption of the applied epoxy. The entire PC board may also be heated in an oven or with a heat lamp.

CAUTION

Some components may be sensitive to high temperatures.

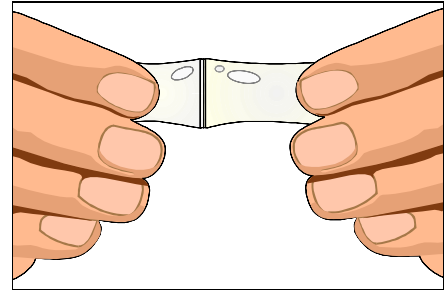

Figure 1: For prepackaged epoxy, remove divider clip and mix resin and hardener inside package.

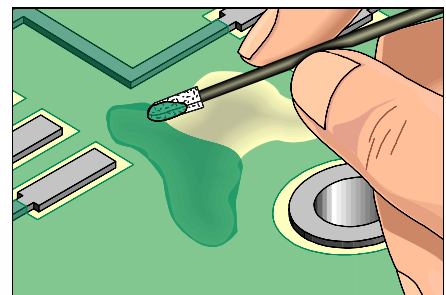

Figure 2: Apply epoxy as needed. Foam swabs may be used to add texture for soldermask repair.

PROCEDURE - Prepackaged Two Part Epoxy

1. Remove the clip separating the resin and hardener. Mix by squeezing both halves together with your fingers. Mix for at least one minute to ensure a complete mix of the resin and activator. (See Figure 1).
2. Cut open one end of the epoxy tube and squeeze the contents into a mixing cup. Mix again with a mixing stick to ensure a thorough mixture of the resin and hardener.

NOTE

For bubble free epoxy, remove the clip separating the resin and hardener. Cut open one end of the Epoxy tube and squeeze the contents into a mixing cup. Slowly stir the mixture with the mixing stick. Be sure to stir the mixture for at least 2 minutes to ensure that all the resin and hardener have completely mixed.

3. If needed, add color agent to the mixed epoxy. Stir slowly to prevent bubbles.
4. Apply or use as needed. (See Figure 2)
5. Cure the epoxy for 24 hours at room temperature or 1 hour @ 165°F (74°C)

EVALUATION

1. Visual examination of epoxy for texture and color match.
2. Testing of epoxy surface for complete cure.
3. Electrical tests as applicable.

OUTLINE

This method is used to repair mechanical or thermal blisters or delaminations in PC board laminated base materials. The blister is sealed by injecting a low viscosity epoxy into the blister/delamination void.

CAUTION

This method can only be used when the laminate base material has separated sufficiently to allow the epoxy to flow throughout the void area.

REFERENCES

- 1.0 Foreword
- 2.1 Handling Electronic Assemblies
- 2.2 Cleaning
- 2.5 Baking and Preheating
- 2.7 Epoxy Mixing and Handling

TOOLS & MATERIALS

Ball Mills
Cleaner
Epoxy
Heat Lamp
Micro-Drill System
Oven
Scraper
Vacuum Source, Optional
Wipes

PROCEDURE

1. Clean the area.
2. Drill into delamination blister with the Micro-Drill and ball mill. Drill in an area clear of circuitry or components. Drill at least two holes opposite each other around the perimeter of the delamination. (See Figure 1). Brush away all loose material.

CAUTION

Be careful not to drill too deep exposing internal circuits or planes.

CAUTION

Abrasion operations can generate electrostatic charges.

3. Bake the PC board to remove any entrapped moisture. Do not allow the PC board to cool prior to injecting the epoxy.

CAUTION

Some components may be sensitive to high temperature.

4. Mix the epoxy. See manufacturers instructions on how to mix epoxy without bubbles.

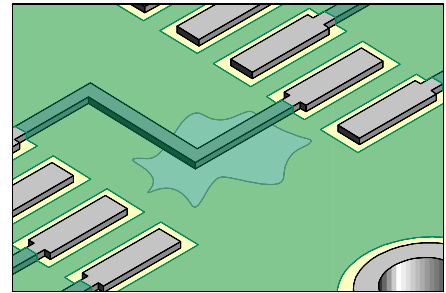

Delamination

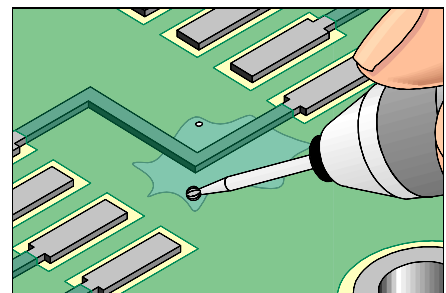

Figure 1: Drill into the delamination blister using a ball mill and a Micro-Drill.

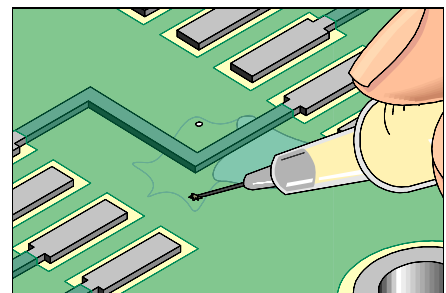

Figure 2: Inject epoxy into the delamination blister.

Figure 3: Completed repair.

CAUTION

Exercise care to prevent bubbles in the epoxy mixture.

5. Pour the epoxy into the epoxy cartridge.
6. Inject the epoxy into one of the holes in the delamination. (See Figure 2). The heat retained in the PC board will improve the flow characteristics of the epoxy and will draw the epoxy into the void area filling it completely.
7. If the void does not fill completely, the following procedures may be used:
 - A. Apply light local pressure on the board surface starting at the fill hole, slowly proceeding to the vent hole.
 - B. Apply vacuum to the vent hole to draw the epoxy through the void.
8. Cure the epoxy per Procedure 2.7 Epoxy Mixing and Handling.
9. Scrape away any excess epoxy using the Precision Knife or Scraper.

NOTE

If needed, apply additional thin coating to seal any scrapped areas.

EVALUATION

1. Visual examination for texture and color match.
2. Electrical tests to conductors around the repaired area as applicable.

OUTLINE

This method is used to eliminate, or reduce the bow and twist, or warping of PC boards. The warping is removed by controlled heating and cooling of the PC board while under restraint.

CAUTION

This repair method is most suitable for FR-4, GE or GF substrate base materials having glass transition temperatures below 125°C (257°F).

CAUTION

This process uses high temperatures. Some components may be sensitive to high temperature.

NOTE

Bow and twist should not be repaired unless sighted as a defect.

REFERENCES

- 1.0 Index
- 2.1 Handling Electronic Assemblies
- 2.5 Baking and Preheating

TOOLS & MATERIALS

Base Plate
Caliper or Pin Gauges
Oven
Restraint Bars
Restraint Clamps

PROCEDURE

1. Check the deflection to determine if rework is needed. See Figure 1.

NOTE

Bow and twist after soldering shall not exceed 1.5% for through-hole PC boards and .75% for surface mount PC boards. The bow and twist shall not be sufficient to cause difficulties during placement, soldering and testing operations. Before dispositioning PC boards with bow and twist as scrap, keep in mind how the PC board is mounted in it's final destination. Keep in mind "form, fit and function" without jeopardizing reliability.

2. Place the restraint bars along the edges that require rework. (See Figure 2).

CAUTION

Components or parts that will interfere with the restraint bars should be removed.

3. If the PC board is warped along more than one edge or more than one plane, clamp the entire PC board to the base plate.

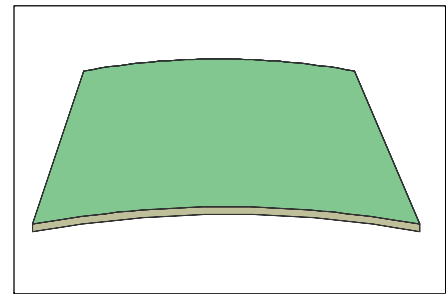

Bow and Twist

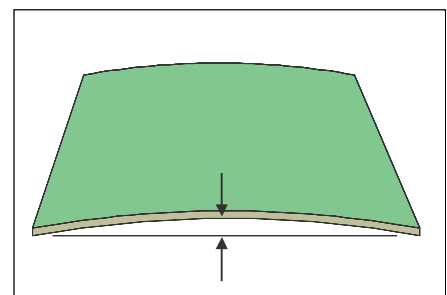

Figure 1: Check edge deflection for maximum warp.

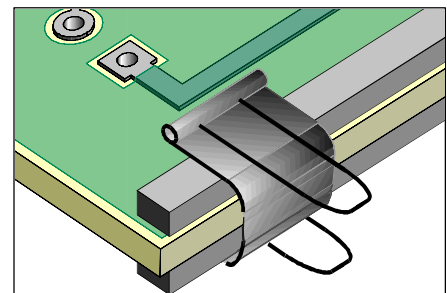

Figure 2: Clamp restraint bars to edge needing rework.

4. Place the PC board, restraint bars and base plate into the oven. Bake for 1 hour at 125°C (257°F).

NOTE

If possible, after the 1 hour bake cycle, shut off the oven and leave the PC board inside. This will allow the PC board to slowly cool to room temperature improving stress relief.

5. Remove from the oven and allow to cool to room temperature.
6. Remove restraint bars.
7. Check the edges deflection using a caliper or pin gauges.

EVALUATION

1. Check for marks or damage along edges.
2. Electrical tests as applicable.

OUTLINE

This method is used to repair cosmetic defects or minor damage to an unsupported tooling or mounting hole. The hole may have component leads, wires, fasteners, pins, terminals or other hardware run through it. This repair method uses high strength epoxy to restore the damaged surface surrounding the hole. This method can be used on single sided, double sided or multilayer PC boards and assemblies.

CAUTION

Damaged inner-layer connections may require surface wire adds.

REFERENCES

- 1.0 Foreword
- 2.1 Handling Electronic Assemblies
- 2.2 Cleaning
- 2.5 Baking and Preheating
- 2.7 Epoxy Mixing and Handling

TOOLS & MATERIALS

Ball Mills
Cleaner
Color Agent
Epoxy
Micro-Drill System
Mixing Sticks
Oven
Precision Knife
Scraper
Tape, High Temperature
Wipes

PROCEDURE

1. Clean the area.
2. Mill away the damaged board base material using the Micro-Drill and ball mill. All damaged base board material and solder mask must be removed. No fibers of laminate material should be exposed at the surface perimeter of the hole. (See Figure 1).

NOTE

To clearly see that all damaged material has been removed, flood the area with alcohol or solvent. Damaged internal fibers of the base material will show up clearly.

3. Remove all loose material and clean the area.

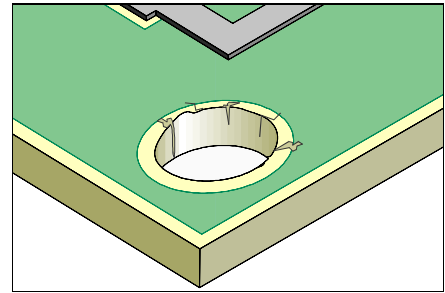

Damaged Hole, Non Plated

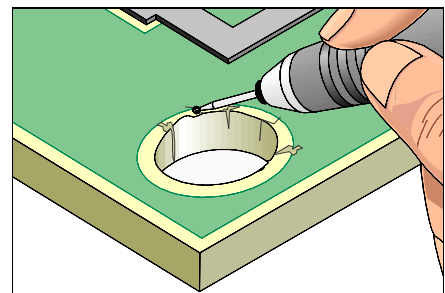

Figure 1: Mill away damaged material with the Micro-Drill and ball mill.

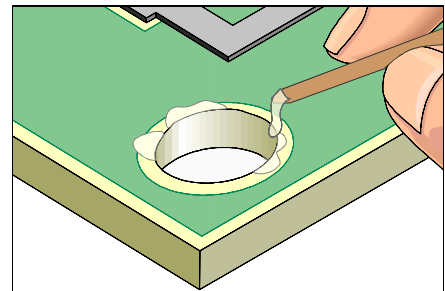

Figure 2: Apply epoxy with a mixing stick sharpened at one end.

4. Where needed, apply High Temperature Tape to protect exposed parts of the PC board. Tape may be required inside the hole. If epoxy reduces the inside diameter, the hole may have to be redrilled after the epoxy has cured.

NOTE

The PC board may be preheated prior to filling the area with epoxy. A preheated PC Board will allow the epoxy to easily flow and level out. Epoxy applied to an unheated PC board may settle below the PC board surface as the epoxy cures.

CAUTION

Some components may be sensitive to high temperatures.

5. Mix the epoxy. If desired, add color agent to the mixed epoxy to match the PC board color.
6. Coat the area with epoxy up to and flush with the PC board surface. A mixing stick may be used to apply and spread the epoxy. (See Figure 2).

NOTE

A slight overfill of epoxy may be desired to allow for shrinkage when epoxy cures.

7. Cure the epoxy per Procedure 2.7 Epoxy Mixing and Handling.
8. After the epoxy has cured, remove the tape.
9. If needed, use the Precision Knife or Scraper and scrape off any excess epoxy. Scrape until the new epoxy surface is level with the surrounding PC board surface.

NOTE

Apply surface coating to match prior coating as required.

10. Remove all loose material. Clean the area.

EVALUATION

1. Visual examination for texture and color match.
2. Hole size measurement to specification
3. Electrical tests to conductors around the repaired area as applicable.

OUTLINE

This method is used to repair severe damage to a hole or to modify the size, shape or location of an unsupported tooling or mounting hole. The hole may have component leads, wires, fasteners, pins, terminals or other hardware run through it. This repair method uses a dowel of matching board material and high strength epoxy to secure the dowel in place. After the new material is bonded in place a new hole can be drilled. This method can be used on single sided, double sided or multilayer PC boards and assemblies.

CAUTION

Damaged inner-layer connections may require surface wire adds.

REFERENCES

- 1.0 Foreword
- 2.1 Handling Electronic Assemblies
- 2.2 Cleaning
- 2.5 Baking and Preheating
- 2.7 Epoxy Mixing and Handling

TOOLS & MATERIALS

Base Material Rod
Cleaner
End Mills
Epoxy
Micro-Drill System
Microscope
Mixing Sticks
Oven
Precision Knife
Precision Drill System
Razor Saw
Tape, High Temperature
Wipes

PROCEDURE

1. Clean the area.
2. Drill out the damaged or improperly sized hole using a carbide end mill or drill. Mill the hole using a precision drill press or milling machine for accuracy. The diameter of the cutting tool should be as small as possible yet still encompass the entire damaged area. (See Figures 1 and 2).

NOTE

Abrasion operations can generate electrostatic charges.

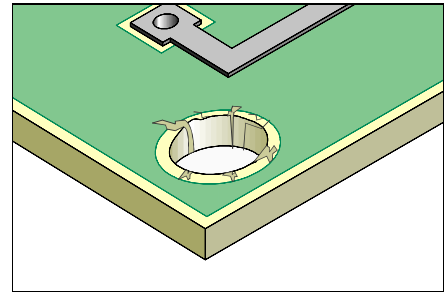

Damaged Hole, Non Plated

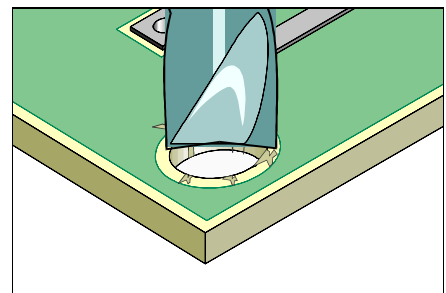

Figure 1: New hole is milled to encompass entire damaged area.



Figure 2: Precision Drill System with microscope.

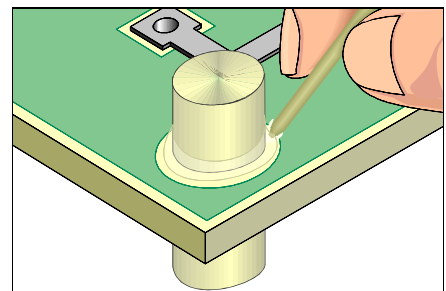

Figure 3: Place replacement dowel in position and bond with epoxy.

3. Cut a piece of replacement base material rod. Base material rod is made from FR-4 dowel stock. Cut the length approximately 12.0 mm (0.50") longer than needed.
4. Clean the reworked area.
5. Use High temperature tape to protect exposed parts of the PC board bordering the rework area.
6. Mix the epoxy.
7. Coat both the dowel and the hole with epoxy and fit together. Apply additional epoxy around perimeter of new material. (See Figure 3). Remove excess epoxy.
8. Cure the epoxy per Procedure 2.7 Epoxy Mixing and Handling.

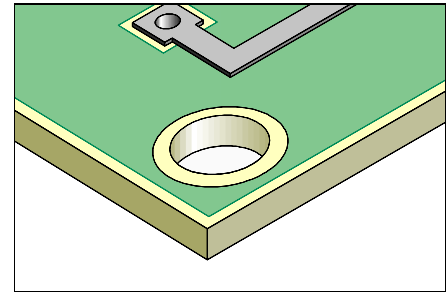

Figure 4: Cut off excess material and redrill holes as required.

- CAUTION**
Some components may be sensitive to high temperatures.
9. Remove tape and cut off the excess material using the razor saw. Mill or file the dowel flush with the board surface. (See Figure 4).
 10. Complete the procedure by redrilling holes and adding circuitry as required. (See Figure 4).

NOTE
Apply surface coating to match prior coating as required.

11. Clean the reworked area.

EVALUATION

1. Visual and dimensional examination of the reworked area for conformance to drawings and specifications.

OUTLINE

This method is used to repair minor damage to a key slot, or other cutout in a printed board or assembly. The area is repaired using high strength epoxy.

CAUTION

Care should be taken to limit the application of epoxy to the specific areas desired and to avoid damage to the conductive patterns, contacts and components.

REFERENCES

- 1.0 Foreword
- 2.1 Handling Electronic Assemblies
- 2.2 Cleaning
- 2.5 Baking and Preheating
- 2.7 Epoxy Mixing and Handling

TOOLS & MATERIALS

Ball Mill
Cleaner
Color Agent
Epoxy
Micro-Drill
Mixing Sticks
Oven
Precision Knife
Scraper
Tape, High Temperature
Wipes

PROCEDURE

1. Clean the area to be filled, including the edges.
2. Mill away the damaged board base material using a Micro Drill System and ball mill. All damaged base board material must be removed. No fibers of laminate material should be exposed at the surface of the keyslot. (See Figure 1).

NOTE

To clearly see that all damaged material has been removed, flood the area with alcohol or solvent. Damaged internal fibers of the base material will show up clearly.

CAUTION

Abrasion operations can generate electrostatic charges.

3. Remove all loose material and clean the area.

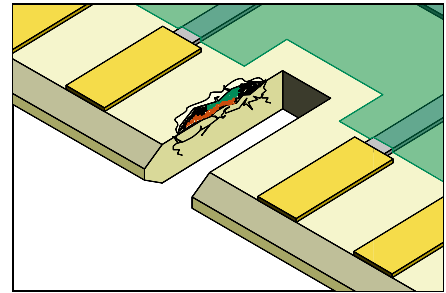

Damaged Key Slot

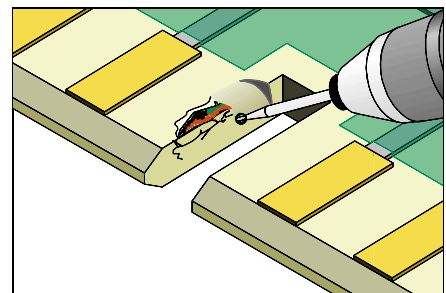

Figure 1: Mill away the damaged board base material using the Micro-Drill System and ball mill.

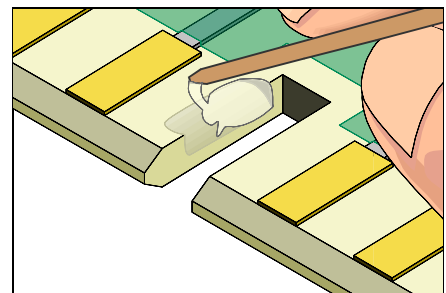

Figure 2: Apply epoxy to the edges of the key slot using a mixing stick sharpened at the end.

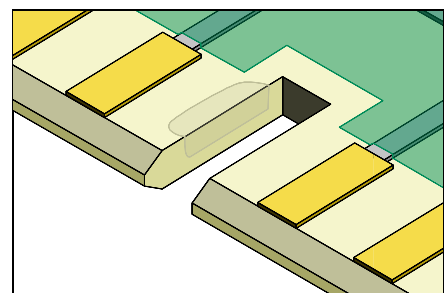

Figure 3: Completed key slot repair.

4. Apply High Temperature Tape to the surface of the PC board adjacent to the slot. The tape should protect any adjacent contacts or components.

NOTE

The PC board may be preheated prior to filling the area with epoxy. A preheated PC Board will allow the epoxy to easily flow and level out. Epoxy applied to an unheated PC board may settle below the PC board surface as the epoxy cures.

5. Mix the epoxy. If desired, add color agent to the mixed epoxy to match the PC board color.
6. Apply a small amount of epoxy to the edges of the slot. A mixing stick sharpened at the end may be used. (See Figure. 2).

NOTE

A slight overfill of epoxy may be desired to allow for shrinkage when epoxy cures.

NOTE

The PC board may be turned on its side to keep the epoxy in place while it cures.

7. Cure the epoxy per Procedure 2.7 Epoxy Mixing and Handling.

CAUTION

Some components may be sensitive to high temperature.

8. After the epoxy has cured remove the tape.
9. If needed use the Precision Knife or Scraper and scrape off any excess epoxy.
10. If precision is required, machine the edges of the slot using a milling machine or Precision Drill System and appropriate milling cutter. Use great care to correctly relocate the slot.

NOTE

If needed, apply additional thin coating to seal any scrapped areas.

11. Clean the area.

EVALUATION

1. Visual examination and measurement of key slot location and dimension.

OUTLINE

This method is used to modify or repair a key slot, or other cutout in a printed board or assembly. A replacement piece of matching board material is epoxied into the area needing repair. A new cut is then machined into the repaired area if needed.

CAUTION

Care should be taken to limit the application of epoxy to the specific areas desired and to avoid damage to the conductive patterns, contacts and components.

REFERENCES

- 1.0 Foreword
- 2.1 Handling Electronic Assemblies
- 2.2 Cleaning
- 2.5 Baking and Preheating
- 2.7 Epoxy Mixing and Handling

TOOLS & MATERIALS

Ball Mills
Base Material
Carbide Saw
Cleaner
End Mills
Epoxy
Micro-Drill System
Milling Machine
Mixing Stick
Oven
Precision Knife
Precision Drill System
Scraper
Tape, High Temperature
Wipes

PROCEDURE

1. Clean the area to be filled, including the edges.
2. Mill out the damaged area using a milling machine or Precision Drill System and carbide end mill. (See Figure 1).
3. Clean the area.
4. Install carbide saw into the Micro-Drill System. Set the speed to maximum and machine a groove in the edge of the PC board where the new base material will be installed. The groove must be centered in the edge to ensure that the new piece will fit properly. The groove width should be approx. 1/3 of the PC board thickness. The groove depth should be approx. double the groove width. (See Figure 2).

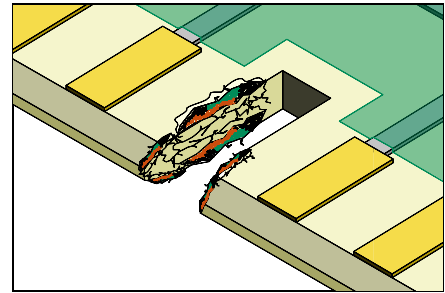

Damaged Key Slot

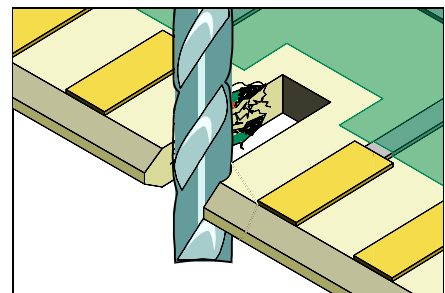

Figure 1: Mill out the damaged area using a milling machine or Precision Drill System.

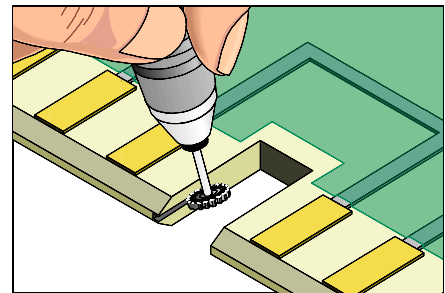

Figure 2: Cut a groove into both sides of the key slot using the Micro-Drill System and carbide saw.

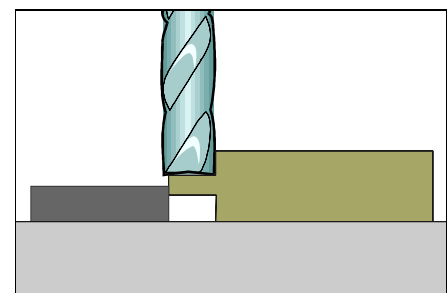

Figure 3: Machine a tongue onto both sides of the replacement base material.

5. Cut a piece of replacement base board material that is the same thickness and type as the PC board. The replacement piece should be longer than the length of the slot to allow for ease of handling.
6. Install an end mill into the milling machine. Machine a tongue onto both sides of the replacement piece. The dimensions of the tongue should match the size of the milled groove. (See Figure 3).
7. Where required apply tape to protect exposed parts of PC board bordering the prepared area.
8. Carefully check the fit of the replacement piece and then clean both the replacement piece and the slot. The replacement base material should fit firmly into the slot so that it will not move or fall out when epoxied in place.
9. Apply tape to the surface of the PC board adjacent to the slot. The tape should protect any adjacent contacts or components.
10. Mix the epoxy.
11. Apply a small amount of epoxy to the edges of the replacement piece and to the inside edges of the slot.
12. Insert the replacement piece into the slot. Check alignment. Remove excess epoxy. (See Figure 4).
13. If needed, apply additional epoxy to the edges of the slot. A mixing stick sharpened at the end may be used to apply the epoxy.
14. Cure the epoxy per Procedure 2.7 Epoxy Mixing and Handling.
CAUTION
Some components may be sensitive to high temperature.
15. After the epoxy has cured remove the tape.
16. If needed use the Precision Knife or Scraper and scrape off any excess epoxy.
NOTE
If needed, apply additional thin coating to seal any scrapped areas.
17. Cut off excess length of replacement material and file to match contour of existing edge. (See Figure 5).
18. If a new slot is needed, machine using milling machine and appropriate milling cutter. Use great care to correctly relocate the slot.
19. Clean the area.

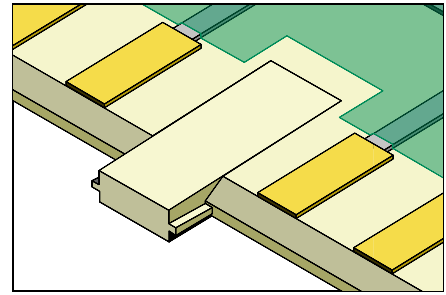

Figure 4: Insert the replacement piece into the slot.

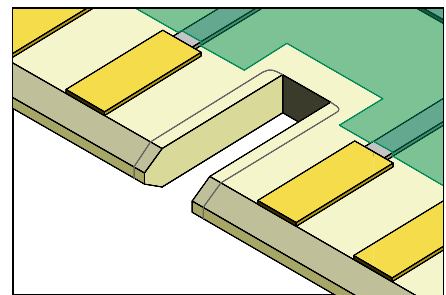

Figure 5: Cut off excess material and file to match edge.

EVALUATION

1. Visual examination and measurement of key slot location and dimension.

OUTLINE

This procedure is used to repair minor damage to PC base board material. Scrapes and scratches in the base board material may be caused by accidents during handling. Burns in the base material may be caused by improper use of soldering and desoldering tools.

CAUTION

This method may be used when the damage extends deep into the base material, but not completely through. If the base board material is damaged completely through, see Procedure No. 3.5.2 or 3.5.3.

CAUTION

Surface circuits may need to be replaced in the damaged area. Be sure that the appropriate circuit diagrams, or photographs reflecting the original circuits are available so that they may be replaced after repairing the base board material. Damage to internal circuits or planes may have to be restored using surface wires.

REFERENCES

- 1.0 Foreword
- 2.1 Handling Electronic Assemblies
- 2.2 Cleaning
- 2.5 Baking and Preheating
- 2.7 Epoxy Mixing and Handling

TOOLS & MATERIALS

Ball Mills
Cleaner
Color Agent
Epoxy
Foam Swab
Halogen Light
Heat Lamp
Micro-Drill System
Microscope
Oven
Precision Knife
Scraper
Tape, High Temperature
Wipes

PROCEDURE

1. Clean the damaged area.
2. Scrape away the damaged base board material using the Precision Knife. All damaged base board material and solder mask must be removed at the surface. (See Figure 1). See step 2A for alternate method.

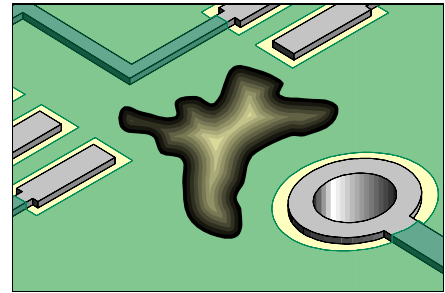

Damaged Base Material

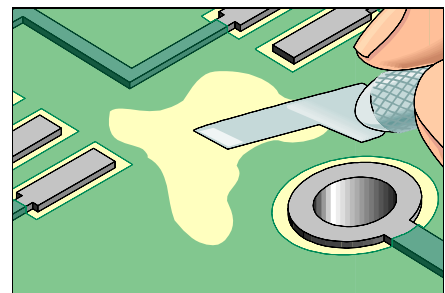

Figure 1: Scrape away damaged base board material with a Precision Knife.



Figure 2: Micro-Drill System.

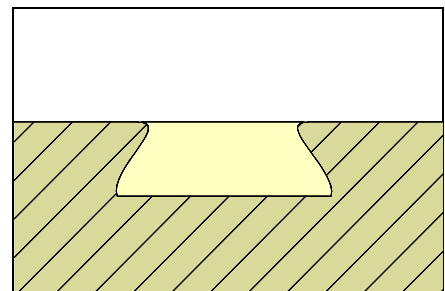

Figure 3: An undercut, to enhance mechanical strength, may be desired for class 3 product.

NOTE

To clearly see that all damaged material has been removed, flood the area with alcohol or solvent. Damaged internal fibers of the base material will show up clearly.

CAUTION

Abrasion operations can generate electrostatic charges.

- 2A. Mill away the damaged base board material using the Micro-Drill System and ball mill. All damaged base board material and solder mask must be removed. (See Figure 2).

NOTE

An undercut to enhance mechanical strength may be desired for class 3 product. (See figure #3).

3. Remove all loose material and clean the area.
4. Where needed, apply High Temperature Tape to protect exposed parts of PC board.

NOTE

The PC Board may be preheated prior to filling the area with epoxy. A preheated PC board will allow the epoxy to easily flow and level out. Epoxy applied to an unheated PC board may settle below the PC board surface as the epoxy cures.

5. Mix the epoxy. If desired, add color agent to the mixed epoxy to match the PC board color.
6. Fill the area with epoxy up to and flush with the PC board surface. No fibers of laminate material should be exposed. A mixing stick sharpened at the end may be used to apply and spread the epoxy. For large areas, apply the epoxy with a foam swab to create a texture in the surface. (See Figures 4 and 5).

NOTE

A slight overfill of epoxy may be desired to allow for shrinkage when epoxy cures.

NOTE

Epoxy may be applied using a foam swab to restore the surface appearance.

7. Cure the epoxy per Procedure 2.7 Epoxy Mixing and Handling.

CAUTION

Some components may be sensitive to high temperature.

8. After the epoxy has cured remove the tape.

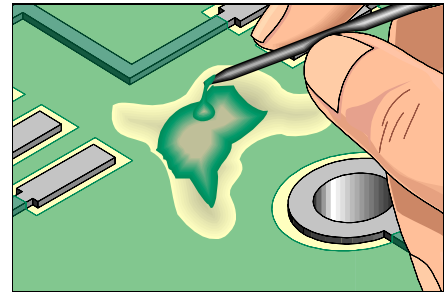

Figure 4: Apply the epoxy with a mixing stick sharpened at the end.

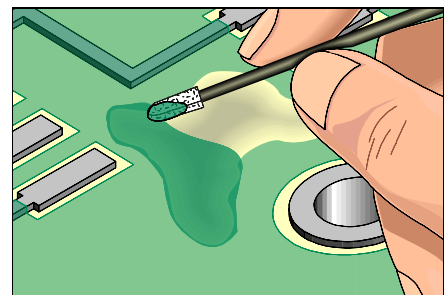

Figure 5: For large areas, apply the epoxy with a foam swab to create a texture in the surface.

9. If needed, use a Precision Knife or Tech-Pro Scraper and scrape off any excess epoxy. Scrape until the new epoxy surface is level with the surrounding PC board surface.
10. Remove all loose material. Clean the area.

NOTE

If needed, apply an additional thin coating to seal any scraped areas.

EVALUATION

1. Visual examination for texture and color match.
2. Electrical tests to conductors around the repaired area as applicable.

OUTLINE

This procedure is used to repair mechanical or thermal damage to PC board base material. This method is used when extended areas of base material must be completely replaced. This method may be used on single sided, double sided or multilayer PC boards or assemblies.

CAUTION

Surface circuits may need to be replaced in the damaged area. Be sure that the appropriate circuit diagrams, or photographs reflecting the original circuits are available so that they may be replaced after repairing the base board material. Damage to internal circuits or planes may have to be restored using surface wires.

REFERENCES

- 1.0 Foreword
- 2.1 Handling Electronic Assemblies
- 2.2 Cleaning
- 2.5 Baking and Preheating
- 2.7 Epoxy Mixing and Handling

TOOLS & MATERIALS

Ball Mills
Base Board Material
Carbide Saw
Cleaner
Color Agent
End Mills
Epoxy
Heat Lamp
Knife
Micro Drill System
Microscope
Oven
Precision Drill System
Scraper
Surgical Saw
Tape, High Temperature
Wipes

PROCEDURE

1. Clean the area
2. Mill away the damaged board material using the Micro-Drill System and ball mill. Remove all evidence of the damaged material. No fibers of laminate material should be exposed. At the surface file the edges to ensure that the opening is rectangular or uniform in shape. (See Figure 1).

CAUTION

Abrasion operations can generate electrostatic charges.

3. Clean the area.

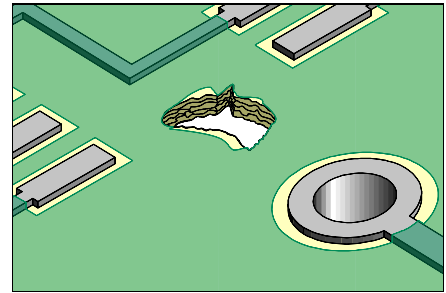

Damaged Base Material

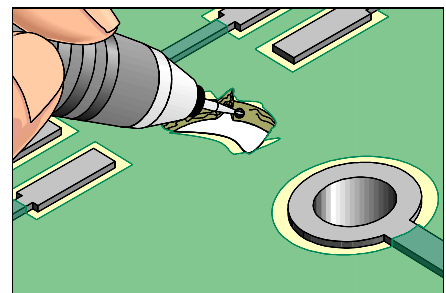

Figure 1: Mill away the damaged base material using the Micro-Drill System and ball mill.

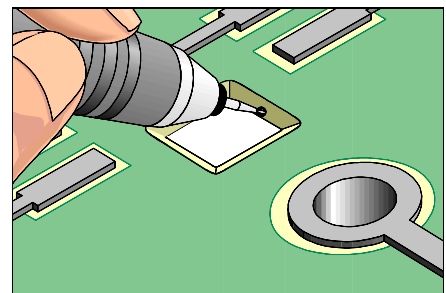

Figure 2: Bevel edge using the Micro-Drill System or file.

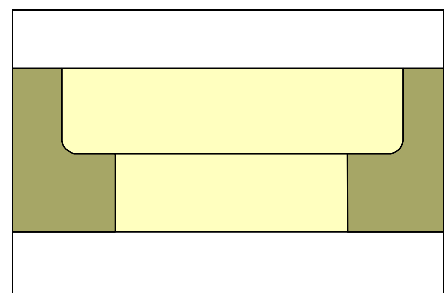

Figure 3: Mill a step into the edge of the PC board.

4A. Bevel the edge using the Micro-Drill System and ball mill or using a file. (See Figure 2).

CAUTION

Exercise care to avoid damage to any internal conductors. If any internal conductors are damaged, surface wires may be required.

4B. Install an end mill into the chuck of a Precision Drill System. Set the speed to maximum and machine a step or lap joint in the edge of the PC board where the new base material will be installed. The depth and width of the step should be approximately 1/2 of the PC board thickness. (See Figure 3).

5. Cut or machine a piece of replacement base board material that is the same thickness and type as the piece removed. The replacement piece must be precisely the same size and shape of the opening including the step joint.

6. Install an end mill into the chuck of a Precision Drill Press. Machine a step onto the entire mating edge of the replacement base material. The dimensions of the step should match the size of the step in the PC board milled groove. (See Figure 4).

7. Where required apply High Temperature Tape to protect exposed parts of PC board bordering the prepared area.

8. Check the fit to be sure the new base material properly mates with the step in the PC board.

9. Mix the epoxy.

10. Coat both the tongue and groove surfaces with epoxy and fit together. (See Figure 5). Remove excess epoxy.

11. Cure the epoxy per Procedure 2.7 Epoxy Mixing and Handling.

12. After the epoxy has cured remove the High Temperature Tape.

13. If needed scrape off any excess epoxy using the Knife or Scraper.

NOTE

If needed, apply additional thin coating to seal any scrapped areas.

14. Clean the area.

15. Complete by drilling holes, slots, etc. or adding circuitry as required.

16. If solder mask replacement or conformal coating is needed see appropriate procedure.

EVALUATION

1. Dimensions of area replaced should be checked to conform to specifications required.

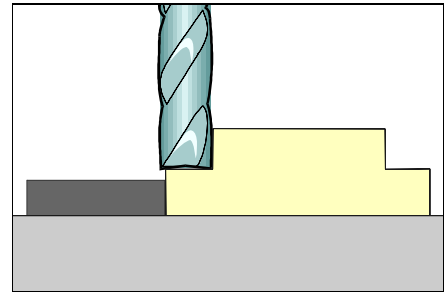

Figure 4: Mill a step onto the edge of the replacement base material.

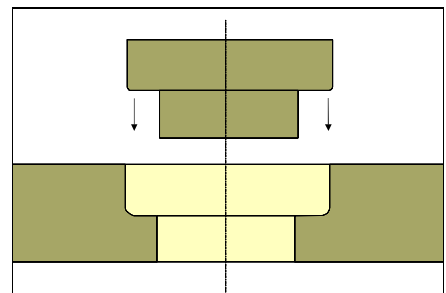

Figure 5: Bond replacement piece in place.

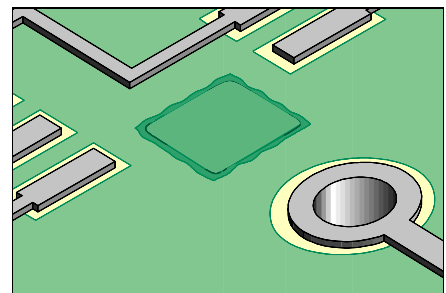

Figure 6: Completed repair.

OUTLINE

This procedure is used to repair mechanical or thermal damage to PC board base material. This method is used when extended areas of base material must be completely replaced. This method may be used on single sided, double sided or multilayer PC boards or assemblies.

CAUTION

Surface circuits may need to be replaced in the damaged area. Be sure that the appropriate circuit diagrams, or photographs reflecting the original circuits are available so that they may be replaced after repairing the base board material. Damage to internal circuits or planes may have to be restored using surface wires.

REFERENCES

- 1.0 Foreword
- 2.1 Handling Electronic Assemblies
- 2.2 Cleaning
- 2.5 Baking and Preheating
- 2.7 Epoxy Mixing and Handling

TOOLS & MATERIALS

Ball Mills
Base Board Material
Carbide Saw
Cleaner
Color Agent
End Mills
Epoxy
Knife
Micro-Drill System
Microscope
Milling Machine
Oven
Precision Drill System
Saw
Scraper
Tape, High Temperature
Wipes

PROCEDURE

1. Clean the area
2. Cut away the damaged board material using the Saw or milling cutter. Remove all evidence of the damaged material. No fibers of laminate material should be exposed. File the edge to ensure that the edge is flat. (See Figure 1).

CAUTION

Exercise care to avoid damage to any internal conductors. If any internal conductors are damaged, surface wires may be required to restore electrical connection.

3. Clean the area.

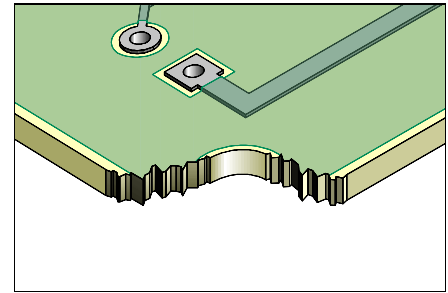

Damaged Base Material

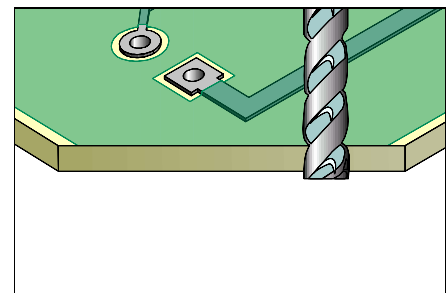

Figure 1: Cut away damaged base material with the Saw or milling cutter.

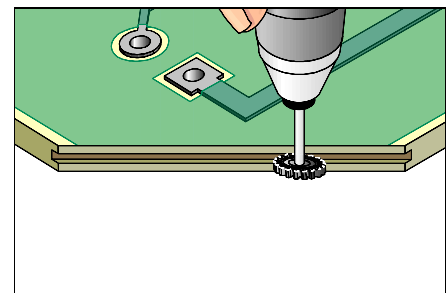

Figure 2: Cut a groove into the edge of the PC board.

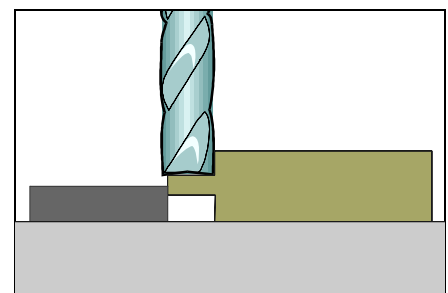

Figure 3: Mill a tongue onto the edge of the replacement base material.

4. Install a carbide saw into the Micro-Drill System. Set the speed to maximum and machine a groove in the edge of the PC board where the new base material will be installed. The groove must be centered in the edge to ensure that the new piece will fit properly. The groove width should be approximately 1/3 of the PC board thickness. The groove depth should be approximately double the groove width. (See Figure 2).
 5. Cut a piece of replacement base board material that is the same thickness and type as the piece removed. The replacement piece may be oversized, the excess material will be removed after the replacement piece has been epoxied in place.
 6. Install an end mill into the chuck of a milling machine. Machine a tongue onto the entire mating edge of the replacement base material. The dimensions of the tongue should match the size of the milled groove. (See Figure 3).
 7. Where required apply High Temperature Tape to protect exposed parts of PC board bordering the prepared area.
 8. Check the fit to be sure the new base material properly mates with the groove in the PC board. (See Figure 4).
 9. Mix the epoxy.
 10. Coat both the tongue and groove surfaces with epoxy and fit together. Remove excess epoxy.
 11. Cure the epoxy per Procedure 2.7 Epoxy Mixing and Handling.
 12. After the epoxy has cured remove the High Temperature Tape.
 13. If needed, scrape off any excess epoxy using the Precision Knife or Tech-Pro Scraper.
- NOTE**
If needed, apply additional thin coating to seal any scrapped areas.
14. Saw or mill off excess base material and file flush with existing edge. (See Figure 5).
 15. Clean the area.
 16. Complete by drilling holes, slots, etc. or adding circuitry as required. (See Figure 6).
 17. If needed, replace solder mask or conformal coating. (See Figure 6).

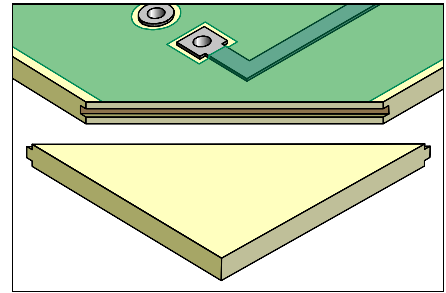

Figure 4: Check fit of new base material. The tongue must mate with the groove in PC board.

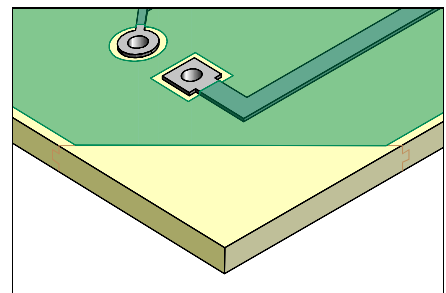

Figure 5: Saw off excess new base material.

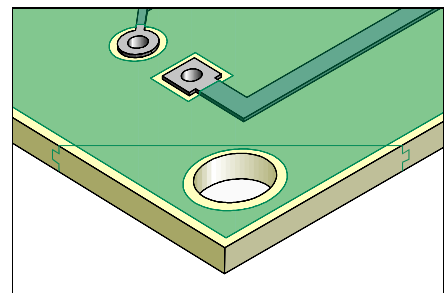

Figure 6: Complete by drilling holes, slots, etc. or adding circuitry and solder mask as required.

EVALUATION

1. Dimensions of area replaced should be checked to conform to specifications required.

OUTLINE

This method is used to rebond a lifted circuit. Liquid epoxy is inserted under and around the circuit to bond it back down to the PC board surface.

CAUTION

This method should not be used to rebond a circuit that has been stretched or damaged.

REFERENCES

- 1.0 Foreword
- 2.1 Handling Electronic Assemblies
- 2.2 Cleaning
- 2.5 Baking and Preheating
- 2.7 Epoxy Mixing and Handling

TOOLS AND MATERIALS

Cleaner
Epoxy
Heat Lamp
Oven
Pick
Precision Knife
Wipes

PROCEDURE

1. Clean the area.
2. Remove any obstructions that prevent the lifted circuit from making contact with the base board surface.

CAUTION

Be careful while cleaning and removing all obstructions, not to stretch or damage the lifted conductor.

3. Clean the area.
4. Mix the epoxy.
5. Carefully apply a small amount of epoxy under the entire length of the lifted circuit. The tip of the Precision Knife may be used to apply the epoxy. (See Figure 1).
6. Press the lifted circuit down into the epoxy and into contact with the base board material.
7. Apply additional epoxy to the surface of the lifted circuit and to all sides as needed.

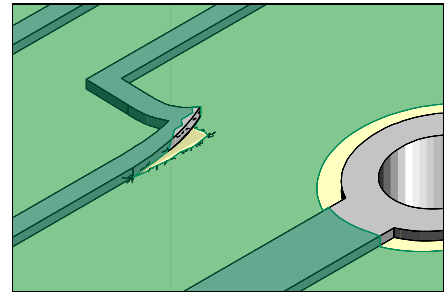

Lifted Conductor

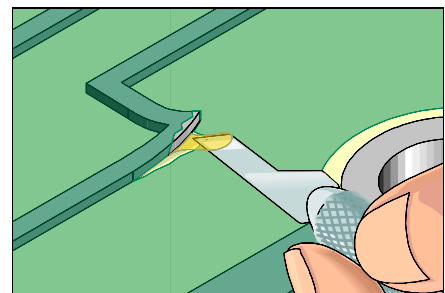

Figure 1: Apply a small amount of epoxy under the entire length of the lifted circuit.

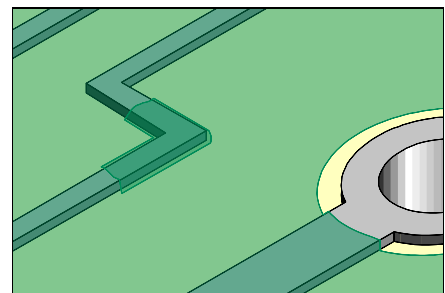

Figure 2: Completed repair.

8. Cure the epoxy per Procedure 2.7 Epoxy Mixing and Handling.

CAUTION

Some components may be sensitive to high temperature.

9. Apply surface coating to match prior coating as required.

EVALUATION

1. Visual examination and tape test per IPC-TM-650 (ANSI/IPC-FC-250A) test method 2.4.1.
2. Electrical tests as applicable.

OUTLINE

This method is used to repair damaged and lifted conductors. Dry film epoxy is used to rebond the lifted conductor.

CAUTION

This method should not be used to rebond a conductor that has been stretched or damaged

REFERENCES

- 1.0 Foreword
- 2.1 Handling Electronic Assemblies
- 2.2 Cleaning
- 2.5 Baking and Preheating

TOOLS & MATERIALS

Bonding Iron
Bonding System
Bonding Tips
Cleaner
Epoxy
Microscope
Precision Knife
Precision Tweezers
Scraper
Tape, High Temperature
Wipes

PROCEDURE

1. Clean the area.
2. Remove any obstructions that prevent the lifted conductor from making contact with the base board surface.

CAUTION

Be careful while cleaning and removing all obstructions, not to stretch or damage the lifted conductor.

3. Clean the area.
4. Cut out a piece of dry film epoxy that closely matches the size of the lifted conductor. Be careful not to contaminate the dry film epoxy with materials that could reduce the bond strength. (See Figure 1).

NOTE

Dry film epoxy thickness should be selected to meet the requirements of the PC Board.

5. Place the dry film epoxy under the lifted conductor. (See Figure 1).

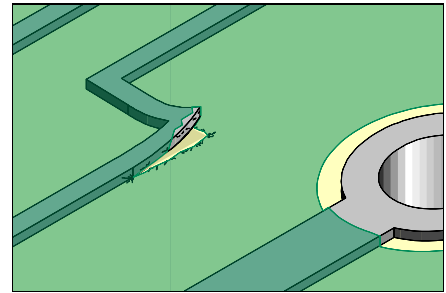

Lifted Conductor

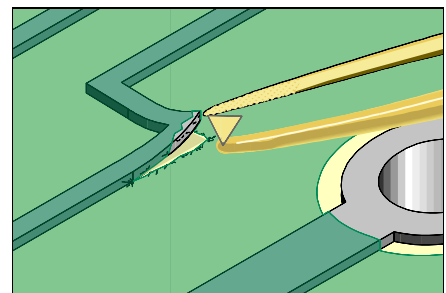

Figure 1: Cut out a piece of dry film epoxy and place it under the lifted conductor.

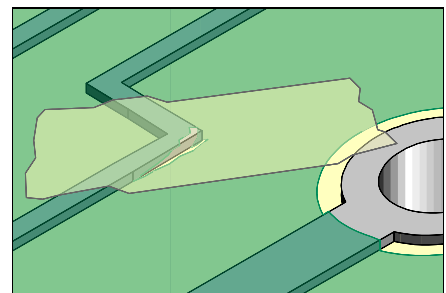

Figure 2: Place Kapton tape over the lifted conductor.



Figure 3: Bond the lifted conductor using a bonding system.

6. Select a bonding tip with a shape to match the shape of the lifted conductor.

NOTE

The bonding tip should be as small as possible but should completely cover the entire surface of the conductor.

7. Place a piece of high temperature tape over the lifted conductor. (See Figure 2).
8. Position the PC board so that it is flat and stable. Gently place the hot bonding tip onto the tape covering the conductor. Apply pressure and heat per equipment manufacturer's recommendation.
9. After the bonding cycle lift the bonding tool and remove the tape used for alignment. The film is fully cured. Carefully clean the area and inspect the conductor.
10. Replace surface coating to match prior coating as required.

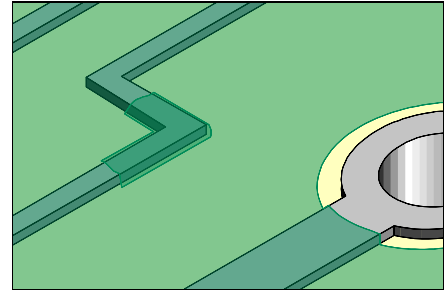

Figure 4: Completed repair.

EVALUATION

1. Visual examination and tape test per IPC-TM-650 (ANCI/IPC-FC-250A) test method 2.4.1.
2. Electrical tests as applicable.

OUTLINE

This method is used on PC boards to replace damaged or missing circuits on the PC board surface.

CAUTION

The circuit widths, spacing and current carrying capacity must not be reduced below allowable tolerances.

REFERENCES

- 1.0 Foreword
- 2.1 Handling Electronic Assemblies
- 2.2 Cleaning
- 2.5 Baking And Preheating
- 2.7 Epoxy Mixing and Handling

TOOLS & MATERIALS

Buffer
Circuit Tracks
Cleaner
Color Agent
Epoxy
Flux, Liquid
Micro-Drill System
Microscope
Oven
Precision Knife
Scraper
Solder
Soldering Iron with Tips
Tape, High Temperature
Wipes

PROCEDURE

1. Clean the area.
2. Remove the damaged section of circuit using a knife. The damaged circuit should be trimmed back to a point where the circuit still has a good bond to the PC board surface.

NOTE

Heat can be applied to the damaged circuit using a soldering iron to allow the circuit to be removed more easily.

3. Use a knife and scrape off any solder mask or coating from the ends of the remaining circuit. (See Figure 1).

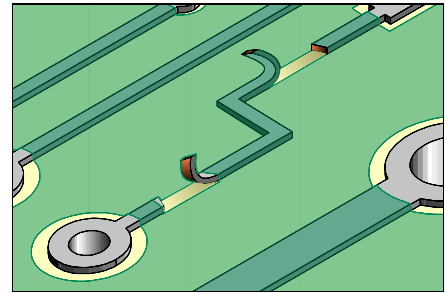

Damaged Conductor

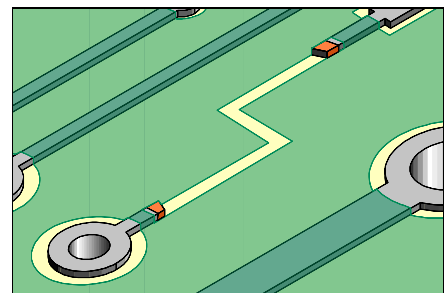

Figure 1: Scrape off any solder mask or coating from the ends of the remaining circuits.

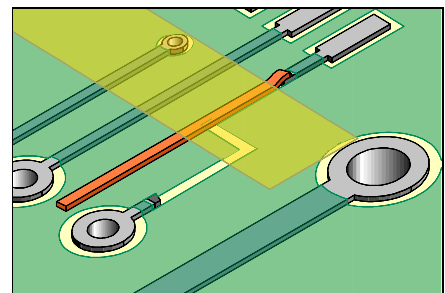

Figure 2: Place the new Circuit Track in position and hold in place with tape.

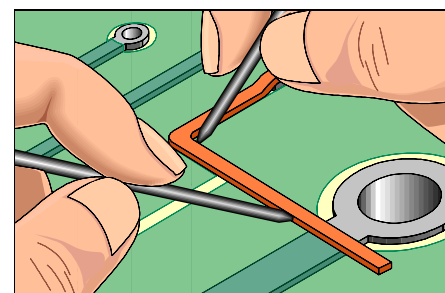

Figure 3: Bend Circuit Track using 2 wood sticks.

- Remove all loose material. Clean the area.

NOTE

It is essential that the board surface be smooth and flat. If the base material is damaged see appropriate procedure.

- Apply a small amount of liquid flux to the ends of the remaining circuit. Tin the exposed end of each circuit using solder and a soldering iron.
- Clean the area.
- Select a Circuit Track to match the width and thickness of the circuit to be replaced. (See Table 1) Cut a length approximately as needed. The Circuit Track should overlap the existing circuit a minimum of 2 times the circuit width.

Table 1
Common Circuit Track Sizes

Thickness	Width
.002"	.004"
.002"	.006"
.002"	.008"
.002"	.010"
.003"	.120"
.003"	.015"
.005"	.020"
.005"	.030"

NOTE

The new circuit may be trimmed from copper sheet.

- Gently abrade the top and bottom surface of the Circuit Track with a buffer to remove the protective coating.

NOTE

A thin protective coating is applied to the Circuit Track to prevent oxidation.

- Clean the Circuit Track.
- If needed, the ends of the Circuit Track may be tinned with solder prior to lap soldering it in place.
- If the Circuit Track is long or has bends, one end may be soldered prior to forming the new shape. Place the Circuit Track in position. The Circuit Track should overlap the existing circuit a minimum of 2 times the circuit width. The Circuit Track may be held in place with Kapton tape. (See Figure 2).

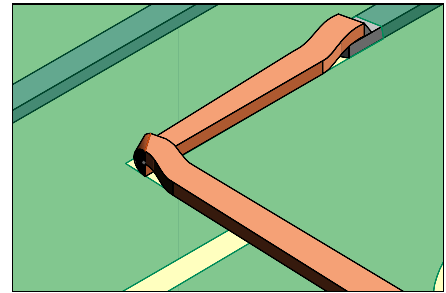

Figure 4: Wide circuits that cannot be easily formed may be folded over to produce a sharp bend.

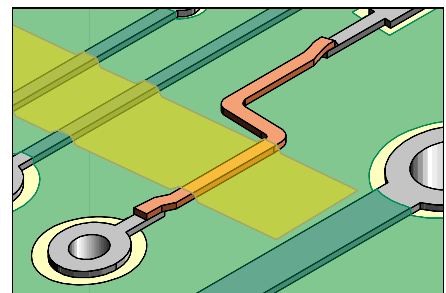

Figure 5: Form the final shape of the Circuit Track then hold in place with tape while soldering.

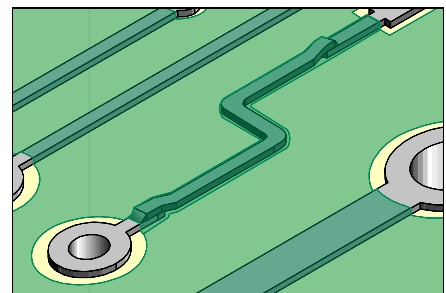

Figure 6: Coat the top and sides of the Circuit Track with epoxy.

12. Apply a small amount of liquid flux to the overlap joint.
13. Lap solder the Circuit Track to the circuit on the PC board surface using solder and a soldering iron. Make sure the Circuit Track is properly aligned.

NOTE

If the configuration permits, the overlap solder joint connection should be a minimum of 3.00 mm (0.125") from the related termination. This gap will minimize the possibility of simultaneous reflow during soldering operations. Refer to 7.1 Soldering Basics.

14. Bend the Circuit Track as needed to match the shape of the missing circuit. (See Figure 3).

NOTE

Two wood sticks can be used to make sharp bends in the replacement Circuit Track. Use one stick to hold the Circuit Track at the bend location and use the other wood stick to form the shape as needed.

15. Wide circuits that cannot be easily formed may be folded over to produce a sharp bend. (See Figure 4).
16. Lap solder the Circuit Track to the remaining circuit on the PC board surface using solder and a soldering iron. Make sure the Circuit Track is properly aligned. (See Figure 5).
17. Mix the Epoxy. If desired, add color agent to the mixed epoxy to match the PC board color.
18. Coat the top and sides of the Circuit Track with epoxy. The epoxy bonds the Circuit Track to the PC board surface and insulates it. A wooden stick sharpened at one end may be used to apply and spread the epoxy. (See Figure 6).
19. Cure the epoxy per Procedure 2.7 Epoxy Mixing and Handling.

CAUTION

Some components may be sensitive to high temperature.

20. Apply surface coating to match prior coating as required.

EVALUATION

1. Visual examination for alignment and overlap of foil jumper.
2. Visual examination of epoxy coating for texture and color match.
3. Electrical tests as applicable.

OUTLINE

This method is used to replace damaged or missing circuits on the PC board surface.

CAUTION

It is essential that the board surface be extremely smooth and flat. If the base board is damaged see appropriate procedure.

REFERENCES

- 1.0 Foreword
- 2.1 Handling Electronic Assemblies
- 2.2 Cleaning
- 2.5 Baking And Preheating
- 2.7 Epoxy Mixing and Handling

TOOLS & MATERIALS

Bonding Iron
Bonding System
Bonding Tips
Buffer
Circuit Frame, Conductors
Cleaner
Epoxy
Flux, Liquid
Heat Lamp
Microscope
Oven
Precision Knife
Scraper
Solder
Soldering Iron
Surgical Knife
Tape, High Temperature
Tweezers
Wipes

PROCEDURE

1. Clean the area.
2. Remove the damaged section of circuit using the knife. The damaged circuit should be trimmed back to a point where the circuit still has a good bond to the PC board surface.
3. Use the knife and scrape off any epoxy residue, contamination or burned material from the board surface.
4. Scrape off any solder mask or coating from the connecting circuit. (See Figure 1).
5. Clean the area.

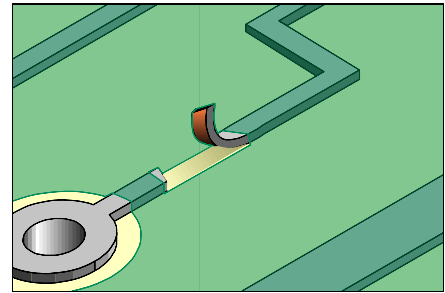

Damaged Conductor

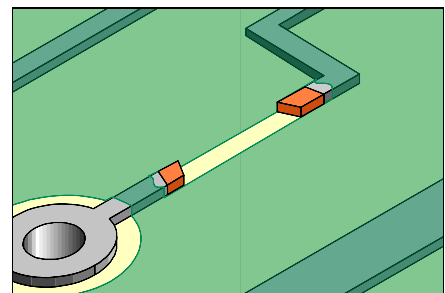

Figure 1: Remove solder mask from the connecting circuit.

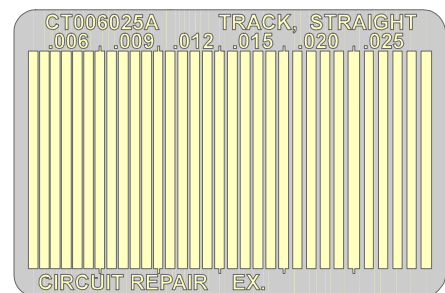

Figure 2: Sample frame or replacement conductors with dry film adhesive backing.

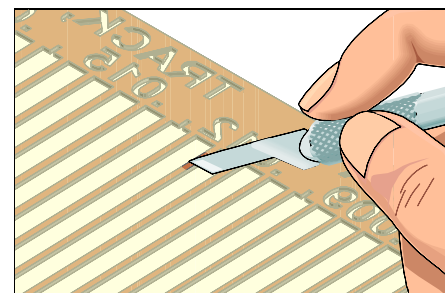

Figure 3: Scrape off epoxy bonding film from solder joint connection area on back of new conductor.

6. Apply a small amount of liquid flux to the connection area on the board surface and tin with solder. Clean the area. The length of the overlap solder connection should be a minimum of 2 times the circuit width.
7. Select a replacement circuit with film adhesive backing that most closely matches the size of the conductor to be replaced. If a special size or shape is needed they can be custom fabricated. (See Figure 2).

NOTE

New conductors are fabricated from copper foil. The foil is plated on the top side with solder and an epoxy bonding film is applied to the bottom side.

8. Before trimming out the new conductor carefully scrape off the adhesive epoxy film from the solder joint connection area on the back of the new conductor. (See Figure 3).

CAUTION

Scrape off the epoxy backing only from the joint connection area. When handling the new conductor avoid touching the epoxy backing with your fingers or other materials that may contaminate the surface and reduce the bond strength.

9. Cut out and trim the new conductor. Cut out from the plated side. Cut the length to provide the maximum allowable circuit overlap for soldering. Minimum 2 times the circuit width. (See Figure 4).

NOTE

If the configuration permits, the overlap solder joint connection should be a minimum of 3.00 mm (0.125") from the related termination. This gap will minimize the possibility of simultaneous reflow during soldering operations. Refer to 7.1 Soldering Basics.

10. Place a piece of Kapton tape over the top surface of the new conductor. Place the new conductor into position on the PC board surface using Kapton tape to help in alignment. Leave the Kapton tape in place during the bonding cycle. (See Figure 5).
11. Select a bonding tip with a shape to match the shape of the new conductor.

NOTE

The bonding tip should be as small as possible but should completely cover the entire width of the new conductor.

12. Position the PC board so that it is flat and stable. Gently place the hot bonding tip onto the Kapton tape covering the new pad. Apply pressure as recommended in the manual of the repair system or repair kit. (See Figure 6).

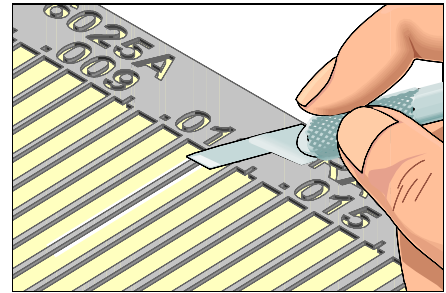

Figure 4: Cut out the new circuit. Cut from the plated side.

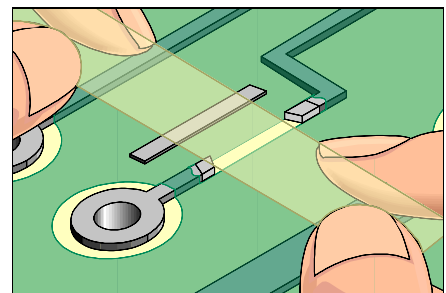

Figure 5: Place the new conductor in place using Kapton tape.



Figure 6: Repair system used to thermally bond dry film adhesive backed replacement conductors.

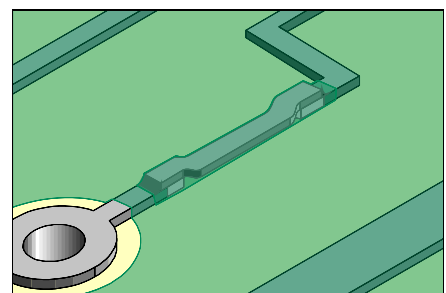

Figure 7: Completed repair.

13. After the bonding cycle lift the bonding iron and remove the Kapton tape used for alignment. The new conductor is fully cured. Carefully clean the area and inspect the new conductor for proper alignment.
14. Apply a small amount of liquid flux to the lap solder joint connection area and solder the circuit foil jumper from the new conductor to the circuit on the PC board surface. Use minimal flux and solder to ensure a reliable connection. Kapton tape may be placed over the top of the new conductor to prevent excess solder overflow.
15. Mix epoxy and coat the lap solder joint connections. Cure the epoxy per Procedure 2.7 Epoxy Mixing and Handling.

CAUTION

Some components may be sensitive to high temperature.

16. Apply surface coating to match prior coating as required.

EVALUATION

1. Visual examination
2. Measurement of new pad width and spacing.
3. Electrical continuity measurement.

OUTLINE

This procedure is used to repair short breaks or opens in circuits on PC boards. A parallel gap welder is used to weld a jumper ribbon across the damaged conductor.

CAUTION

Welding current and voltages may affect component reliability on assembled PC boards. The repaired section must not reduce the circuit width, spacings or current carrying capacity below the allowable tolerances.

CAUTION

Sub miniature parallel gap welding is extremely sensitive to proper placement of the electrode tip. Inconsistent welds can occur due to poor electrode tip placement, incorrect tip size, or improper weld settings.

REFERENCES

- 1.0 Foreword
- 2.1 Handling Electronic Assemblies
- 2.2 Cleaning
- 2.7 Epoxy Mixing and Handling

PREPARATION

Prior to using any welding equipment, certain precautions should be taken. The equipment should have electrodes cleaned, aligned and set for the proper board thickness.

Test samples that have similar circuit widths, spacing, thickness, surface finish, contour, etc. Observe and test the weld quality, alignment, discoloration, fusion and the appearance of the base material in the area of the weld. Readjust the weld equipment settings and repeat until acceptable results have been achieved.

The alignment of the welded ribbon to the circuit pattern should be within 0.050 mm (.002"). The weld bond strength should exceed the circuit/base material bond strength.

TOOLS & MATERIALS

Cleaner
Epoxy
Flux, Liquid
Kovar Ribbon
Microscope
Parallel Gap Welder
Precision Knife
Ribbon - Gold Plated Kovar
Solder
Soldering Iron
Tweezers
Wipes

PROCEDURE

1. Clean the area.
2. Select a section of Kovar ribbon of the same width as the conductor pattern being repaired $\pm .050$ mm (0.002").
3. Cut the ribbon approximately 3.0 mm (.120") longer than the section being repaired.
4. Clean the ribbon conductor and base material surrounding the repair area.
5. Place and center the ribbon over the section to be repaired leaving equal ribbon end lengths on each side and parallel to the circuit pattern.
6. Place the PC board under the weld electrodes so that the electrodes are depressed to the area of the weld.
7. Hold the ribbon in place with the Precision Tweezers until the weld is completed. Weld in place using settings based on the accepted test samples.
8. Clean the area.
9. Carefully inspect the joint for weld quality and alignment.
10. If required, apply a small amount of flux and tin the entire area with solder.
11. Clean the area.
12. Coat the repaired area with epoxy if needed.

EVALUATION

1. Visual examination, dimensional measurement of conductor width and spacing, and electrical continuity measurement.

OUTLINE

This method is used on PC boards to replace damaged or missing circuits on the PC board surface. A length of standard insulated or non insulated wire is used to repair the damaged circuit.

CAUTION

The circuit widths, spacing and current carrying capacity must not be reduced below allowable tolerances.

REFERENCES

- 1.0 Foreword
- 2.1 Handling Electronic Assemblies
- 2.2 Cleaning
- 2.5 Baking And Preheating
- 2.7 Epoxy Mixing and Handling
- 6.1 Jumper Wires

TOOLS AND MATERIALS

Cleaner
Epoxy
Flux, Liquid
Heat Lamp
Light, Gooseneck, Halogen
Microscope
Oven
Precision Knife
Scraper
Solder
Soldering Iron with Tips
Tape Dots
Tape, High Temperature
Wipes
Wire
Wire Guide

PROCEDURE

1. Clean the area.
2. Remove the damaged section of circuit using the knife. The damaged circuit should be trimmed back to a point where the circuit still has a good bond to the PC board surface.

NOTE

Heat can be applied to the damaged circuit using a soldering iron to allow the circuit to be removed more easily.

3. Use a knife and scrape off any solder mask or coating from the ends of the remaining circuit. (See Figure 1).

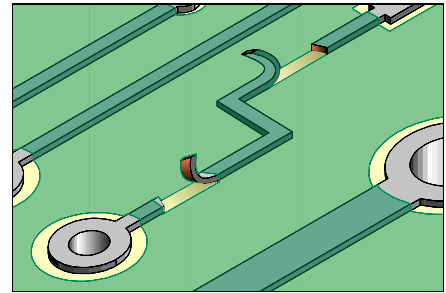

Damaged Conductor

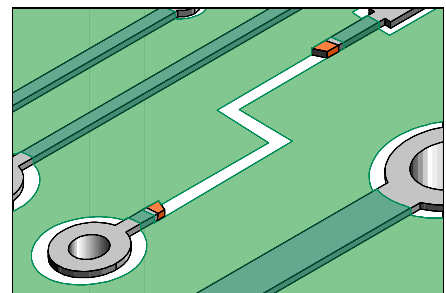

Figure 1: Scrape off any solder mask or coating from the ends of the remaining circuits.

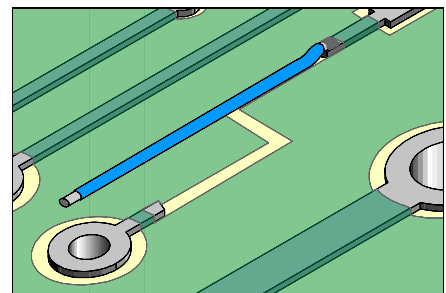

Figure 2: Lap solder the wire to one end of the circuit on the PC board surface.

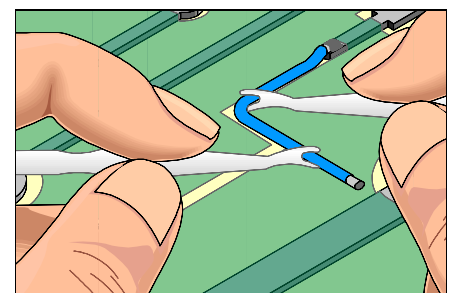

Figure 3: Form wire using a Wire Guide.

4. Remove all loose material. Clean the area.
5. Apply a small amount of liquid flux to the ends of the remaining circuit. Tin the exposed end of each circuit using solder and a soldering iron.
6. Clean the area.
7. Select a wire to match the width and thickness of the circuit to be replaced. Cut a length approximately as needed. See Table 1 for Solid Wire Equivalents.

Table 1
Solid Wire Equivalents

Conductor Width 2 oz. Copper	Equivalent Solid Wire Diameter
.010" (0.25 mm)	#34, .006" (0.15 mm)
.015" (0.38 mm)	#32, .008" (0.20 mm)
.020" (0.50 mm)	#31, .009" (0.23 mm)
.031" (0.78 mm)	#29, .011" (0.28 mm)
.082" (2.08 mm)	#26, .018" (0.46 mm)
.125" (3.18 mm)	#23, .023" (0.58 mm)
When using solid wire to repair a conductor, there should be no reduction in the cross sectional area.	

8. Strip the wire and tin the ends if needed. Non insulated wire may be used for short repairs if conductors are not crossed.
9. Clean the wire.
10. If the wire is long or has bends, one end may be soldered prior to forming the new shape. Place the wire in position. The wire should overlap the existing circuit a minimum of 2 times the circuit width. The wire may be held in place with Kapton tape during soldering.

NOTE

If the configuration permits, the overlap solder joint connection should be a minimum of 3.00 mm (0.125") from the related termination. This gap will minimize the possibility of simultaneous reflow during soldering operations. Refer to 7.1 Soldering Basics.

11. Apply a small amount of liquid flux to the overlap joint.
12. Lap solder the wire to one end of the circuit on the PC board surface. Make sure the wire is properly aligned. (See Figure 2).
13. Bend the wire as needed to match the shape of the missing circuit. (See Figure 3).

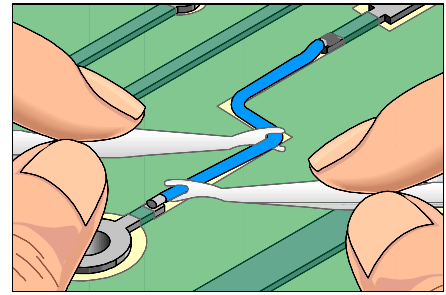

Figure 4: Form the final shape of the wire and solder in place.

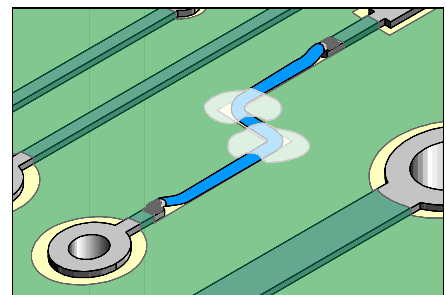

Figure 5: Bond the wires to the surface with adhesive or Tape Dots.

NOTE

A Wire Guide Tool can be used to form the wire as needed.

14. Lap solder the other wire end to the remaining circuit on the PC board surface using solder and a soldering iron. Make sure the wire is properly aligned. (See Figure 4).
15. Remove any Kapton tape and clean the area.

NOTE

It may be necessary to encapsulate the solder joint connection if electrical spacing is reduced or the connection is beneath a component.

16. If desired bond the wire to the PC board surface with adhesive, epoxy or Tape Dots. (See Figure 5). Refer to Procedure 6.1.

CAUTION

Some components may be sensitive to high temperature.

17. Cure the epoxy per Procedure 2.7 Epoxy Mixing and Handling.
18. After the epoxy has cured clean the area.

EVALUATION

1. Visual examination for alignment and overlap of wire.
2. Electrical tests as applicable.

OUTLINE

This method is used on PC boards to replace damaged or missing circuits on the PC board surface. A length of standard insulated or non insulated wire is used to repair the damaged circuit.

CAUTION

The circuit widths, spacing and current carrying capacity must not be reduced below allowable tolerances.

REFERENCES

- 1.0 Foreword
- 2.1 Handling Electronic Assemblies
- 2.2 Cleaning
- 2.5 Baking And Preheating
- 2.7 Epoxy Mixing and Handling
- 6.1 Jumper Wires

TOOLS AND MATERIALS

Cleaner
Flux, Liquid
Light, Gooseneck, Halogen
Micro-Drill System
Microscope
Precision Knife
Solder
Soldering Iron with Tips
Tape Dots
Wipes
Wire
Wire Guide

PROCEDURE

1. Clean the area.
2. Remove the damaged section of circuit using the knife. The damaged circuit should be trimmed back to a point where the circuit still has a good bond to the PC board surface.

NOTE

Heat can be applied to the damaged circuit using a soldering iron to allow the circuit to be removed more easily.

3. Use a knife and scrape off any solder mask or coating from the ends of the remaining circuit. (See Figure 1).
4. Remove all loose material. Clean the area.
5. Apply a small amount of liquid flux to the ends of the remaining circuit. Tin the exposed end of each circuit using solder and a soldering iron.

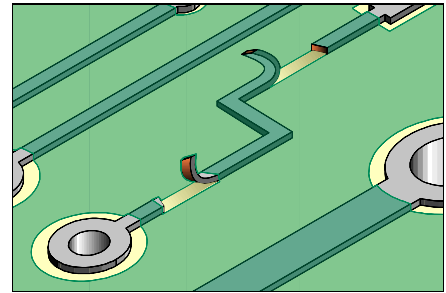

Damaged Conductor

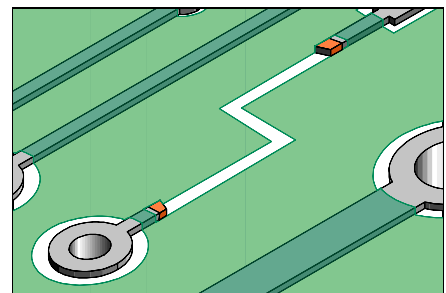

Figure 1: Scrape off any solder mask or coating from the ends of the remaining circuits.

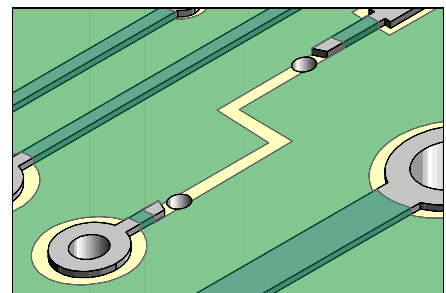

Figure 2: Drill through the board adjacent to both ends of the remaining circuits.

Figure 3: Bend the stripped wire over the prepared circuits in line with the circuits.

6. Clean the area.
7. Select a wire to match the width and thickness of the circuit to be replaced. Cut a length approximately as needed. See Table 1 for Solid Wire Equivalents.

Table 1
Solid Wire Equivalents

Conductor Width 2 oz. Copper	Equivalent Solid Wire Diameter
.010" (0.25 mm)	#34, .006" (0.15 mm)
.015" (0.38 mm)	#32, .008" (0.20 mm)
.020" (0.50 mm)	#31, .009" (0.23 mm)
.031" (0.78 mm)	#29, .011" (0.28 mm)
.082" (2.08 mm)	#26, .018" (0.46 mm)
.125" (3.18 mm)	#23, .023" (0.58 mm)
When using solid wire to repair a conductor, there should be no reduction in the cross sectional area.	

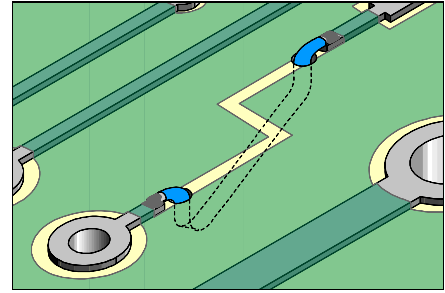

Figure 4: Lap solder the wire to the circuits on the PC board surface.

8. Strip the wire and tin the ends if needed. Non insulated wire may be used for short repairs if conductors are not crossed.
9. Clean the wire.
10. Drill through the board adjacent to both ends of the remaining circuits. Drill the hole slightly larger than the wire diameter to be used. (See Figure 2).

CAUTION

Review circuit diagrams to be sure no surface or internal circuits will be damaged or shorted.

11. Position the wire on the opposite side from the repair and insert the stripped ends into the drilled holes.
12. Bend the stripped wire over the prepared circuits in line with the circuits. The wire should overlap the existing circuit a minimum of 2 times the circuit width. (See Figure 3).

NOTE

If the configuration permits, the overlap solder joint connection should be a minimum of 3.00 mm (0.125") from the related termination. This gap will minimize the possibility of simultaneous reflow during soldering operations. Refer to 7.1 Soldering Basics.

13. Apply a small amount of liquid flux to the overlap joint.

14. Lap solder the wire to the circuits on the PC board surface. Make sure the wire is properly aligned. (See Figure 4).
15. Form the wire on the opposite side to match the shape of the missing circuit, if desired.
16. Clean the area.

NOTE

It may be necessary to encapsulate the solder joint connection if electrical spacing is reduced.

17. If desired bond the wire to the PC board surface with adhesive, epoxy or Tape Dots. Refer to Section 6.0.

CAUTION

Some components may be sensitive to high temperature.

18. Cure the epoxy per Procedure 2.7 Epoxy Mixing and Handling.
19. After the epoxy has cured clean the area.

EVALUATION

1. Visual examination for alignment and overlap of wire.
2. Electrical tests as applicable.

OUTLINE

This method is used to replace damaged or missing circuits on internal layers of multilayer PC boards.

CAUTION

The circuit widths, spacing and current carrying capacity must not be reduced below allowable tolerances.

CAUTION

The overlap joint used in this method may cause problems with high frequency circuitry.

CAUTION

This procedure is complicated and should be attempted only by properly skilled repair personnel using the best tools and equipment.

REFERENCES

- 1.0 Foreword
- 2.1 Handling Electronic Assemblies
- 2.2 Cleaning
- 2.5 Baking and Preheating
- 2.7 Epoxy Mixing and Handling

TOOLS AND MATERIALS

Ball Mills
Buffer
Circuit Tracks
Cleaner
Color Agent
Epoxy
Flux, Liquid
Heat Lamp
Micro-Drill System
Microscope
Oven
Precision Knife
Scraper
Solder
Soldering Iron
Tape, High Temperature
Wipes

PROCEDURE

1. Locate and determine the coordinates where the repair is to be made. Use films or master drawings of the board as needed.

NOTE

Obtain as much information as possible on the conductive and non-conductive layers prior to starting the procedure.

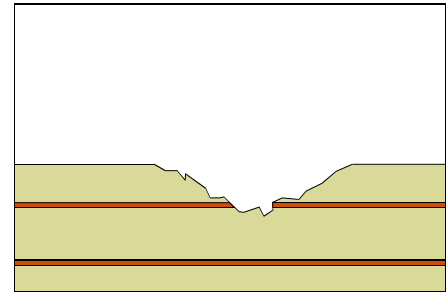

Damaged Inner Layer

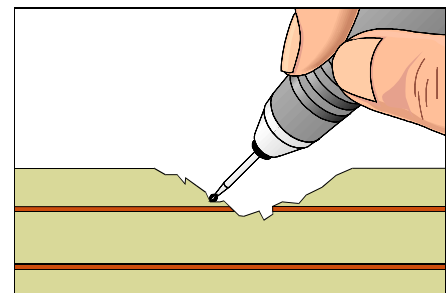

Figure 1: Milling into multilayer PC board to expose the damaged internal circuit.



Figure 2: A high quality, Micro-Drill System is recommended for this delicate operation.

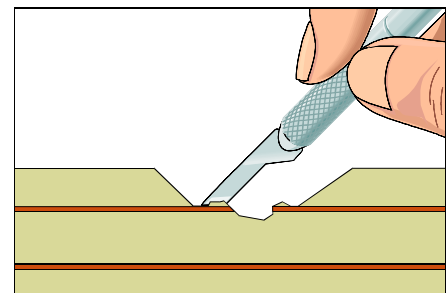

Figure 3: Remove the remaining board material covering the internal circuit using the knife.

- Remove components from the immediate area if necessary and clean the area.
- Use the microscope and Micro-Drill System and cut through the base material, one layer at a time, until the desired inner layer has been reached. (See Figure 1 and 2).

CAUTION

Great care should be taken to prevent further damage to internal circuits.

- Each internal circuit should have a flat section exposed to allow the new circuit to be soldered in place. (See Figure 3).

NOTE

To reduce damage to the internal circuit, complete the final exposure of the internal circuit using a knife. (See Figure 3).

- Remove all loose material. Clean the area.
- Apply a small amount of liquid flux to the ends of the internal circuit. Tin the exposed end of each circuit using solder and a soldering iron.
- Clean the area.
- Select a Circuit Track to match the width and thickness of the circuit to be replaced. Cut a length approximately as needed. The Circuit Track should overlap the existing circuit a minimum of 2 times the circuit width.
- Gently abrade the top and bottom of the Circuit Track with the buffer to remove any protective coating and clean.

NOTE

If needed, the ends of the Circuit Track may be tinned with solder prior to lap soldering in place.

- Place the Circuit Track in position. The Circuit Track should overlap the existing circuit a minimum of 2 times the circuit width. (See Figure 4).

NOTE

If spacing is critical or the PC Board uses high frequency circuits, bevel the joint. (See Figure 5).

CAUTION

This bevel joint method may cause problems with PC Boards exposed to extreme temperature fluctuations.

- Apply a small amount of liquid flux to the overlap joint.
- Lap solder the Circuit Track to the exposed internal circuit using solder and a soldering iron. Make sure the new circuit is properly aligned.

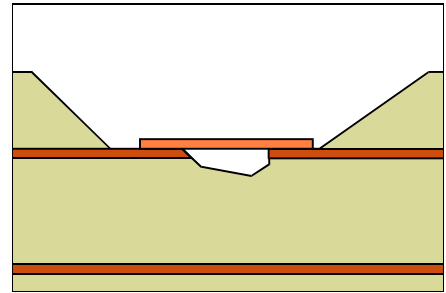

Figure 4: Circuit Track in place ready to be soldered.

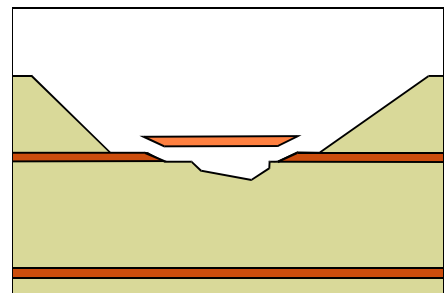

Figure 5: If spacing is critical or the PC board uses high frequency circuits, bevel the joint as shown.

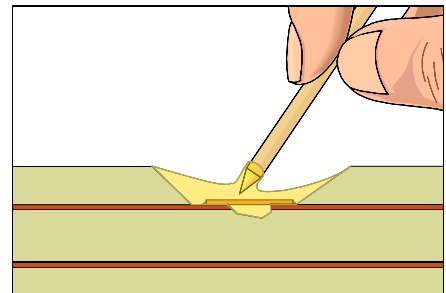

Figure 6: Coat the top and sides of the new circuit with epoxy. Add epoxy until flush with top surface.

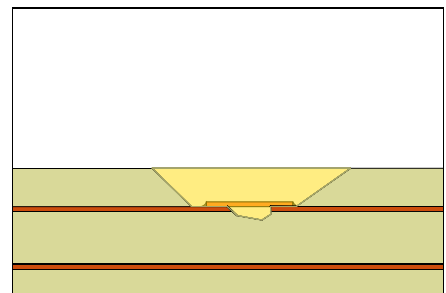

Figure 7: Completed repair.

13. Clean the area.

NOTE

The PC Board may be preheated prior to filling the area with epoxy. A preheated PC Board will allow the epoxy to easily flow and level out. Epoxy applied to an unheated PC board may settle below the PC board surface as the epoxy cures.

14. Mix epoxy. If desired, add color agent to the mixed epoxy to match the PC board color.

15. Coat the top and sides of the replaced circuit with epoxy. The epoxy bonds the new circuit to the base board material and insulates the circuit. Continue adding epoxy up to the top surface of the PC board or to the height of the next internal circuit. (See Figure 6).

NOTE

A slight overfill of epoxy may be desired to allow for shrinkage when the epoxy cures.

16. Cure the epoxy per Procedure 2.7 Epoxy Mixing and Handling.

CAUTION

Some components may be sensitive to high temperature.

17. Add additional Circuit Tracks if needed and coat with additional epoxy.

18. Continue completing all layers until the top surface of the PC board is reached. (See Figure 7).

19. Clean the board as required.

20. Apply surface coating to match prior coating as required.

EVALUATION

1. Visual examination for alignment and overlap of new circuit.
2. Visual examination of epoxy coating for texture and color match.
3. Electrical tests as applicable.

OUTLINE

This method is used to sever a circuit or short. A small section of the circuit is removed forming a break. The width of the break should be at least as wide as the minimum conductor spacing. The Surgical Knife or high speed, Micro-Drill System is used. This method is recommended for surface circuit cuts only. After cutting, the area is sealed with epoxy.

NOTE

This method is recommended for surface circuit cuts only.

REFERENCES

- 1.0 Foreword
- 2.1 Handling Electronic Assemblies
- 2.2 Cleaning
- 2.7 Epoxy Mixing and Handling

TOOLS AND MATERIALS

- Ball Mills
- Cleaner
- Color Agent
- Continuity Meter
- Epoxy
- Heat Lamp
- Micro-Drill System
- Microscope
- Oven
- Precision Knife
- Wipes

PROCEDURE

1. Identify the circuit or short to be cut. Determine from the artwork or drawings where the best location is to make the break. The width of the break should at least match the minimum required electrical spacing.
2. Clean the area.
3. Carefully make two small cuts with the knife and remove the short section of circuit. (See Figure 1).

OR

4. Select the appropriate size ball mill and insert it into the Micro-Drill System. Set the speed to high. (See Figure 2). The ball mill should be approximately the same width as the circuit to be cut.

NOTE

Ball mills should be dental grade carbide steel for precision cutting and long life.

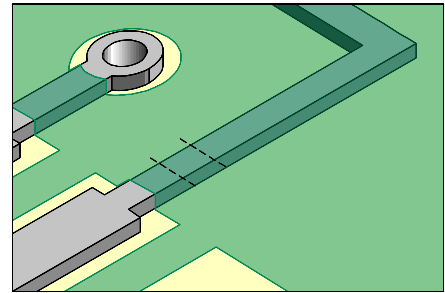

Circuit Cut, Surface Circuit

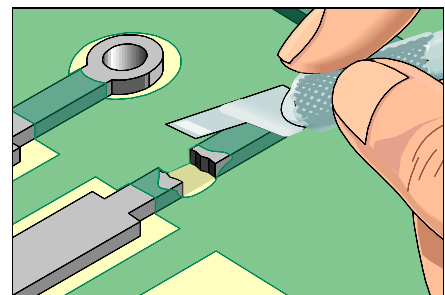

Figure 1: Option A - Make two small cuts with the knife and remove a short section of circuit.



Figure 2: A high quality, Micro-Drill System is recommended for this delicate operation.

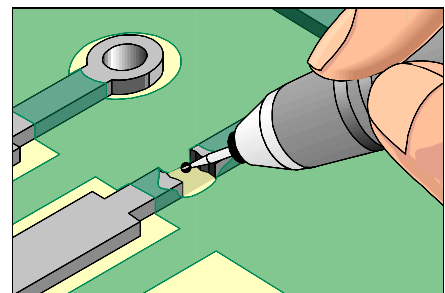

Figure 3: Make 1 or 2 cuts as needed to cut circuit.

- Carefully make 1 or 2 cuts as needed. (See Figure 3).

CAUTION

Exercise care to avoid damage to adjoining circuits.

- Check continuity to be sure that the circuit has been cut.
- Clean the area.
- Mix epoxy. If desired, add color agent to the mixed epoxy to match the PC board color.
- Coat the area with epoxy if needed. An epoxy dispenser may be used to control the application of epoxy. Remove any excess.
- Cure the epoxy per Procedure 2.7 Epoxy Mixing and Handling.

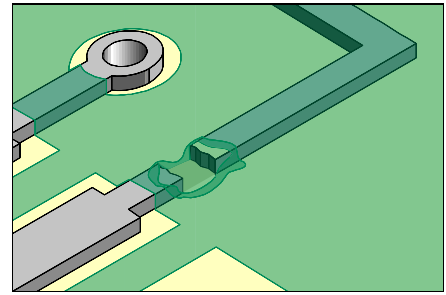

Figure 4: Completed repair.

EVALUATION

- Visual examination of cuts for spacing, and unintended damage to surrounding circuits.
- Electrical tests as applicable.

OUTLINE

This method is used to sever a circuit or short. A small section of the circuit is removed forming a break. The width of the break should be at least as wide as the minimum conductor spacing. The Precision Drill System is used with a carbide end mill. This method is recommended for surface or inner layer circuit cuts. After milling, the area is sealed with epoxy.

NOTE

This method is recommended for surface or inner layer circuit cuts.

CAUTION

Extreme care must be taken to prevent damage to adjacent or underlying inner layer circuits. A microscope must be used during milling when extreme accuracy is required.

REFERENCES

- 1.0 Foreword
- 2.1 Handling Electronic Assemblies
- 2.2 Cleaning
- 2.7 Epoxy Mixing and Handling

TOOLS AND MATERIALS

Cleaner
Color Agent
Continuity Meter
End Mills
Epoxy
Heat Lamp
Microscope
Oven
Precision Drill System
Wipes

PROCEDURE

1. Identify the circuit or short to be cut. Determine from the artwork or drawings where the best location is to make the break. The width of the break should at least match the minimum required electrical spacing.
2. Clean the area.
3. If the cut is on an inner layer circuit, mark the coordinates on the PC board surface or set up a fixture to precisely locate the board in the Precision Drill System. (See Figure 1).
4. Select the appropriate size end mill or ball mill and insert it into the chuck of the Precision Drill System. The milling cutter should be slightly larger in diameter than the circuit to be cut. Set speed to high.

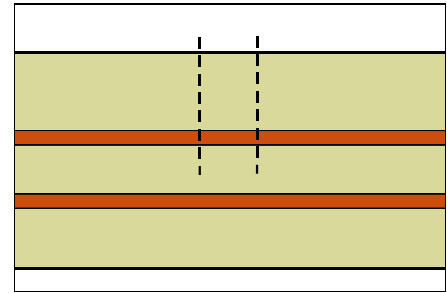

Circuit Cut, Inner Layer



Figure 1: Precision Drill System with base plate to pin PC board in position while cutting circuits.

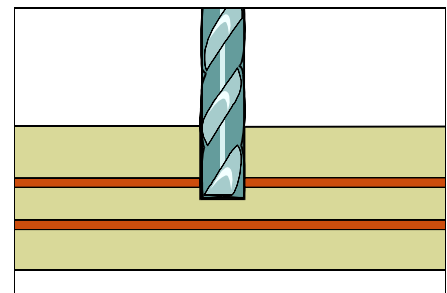

Figure 2: Mill into PC board at proper coordinates to cut inner layer circuits as required.

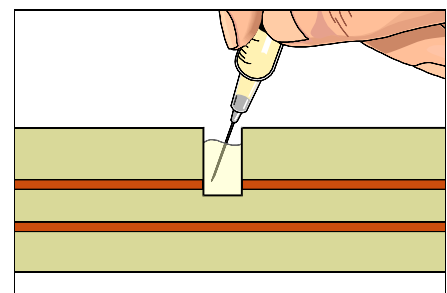

Figure 3: Fill the milled hole with epoxy up to and flush with the surface.

NOTE

End mills are normally single end, two or four flute high grade solid carbide.

5. Mill down into the board at the proper coordinates to cut the inner layer circuits or to break the inner layer short. Do not mill deeper than needed. A microscope should be used for accuracy. (See Figure 2).
6. Blow away material with air and clean the area.
7. Check continuity to be sure that the circuit has been cut.
8. Mix epoxy. If desired, add color agent to the mixed epoxy to match the PC board color.
9. Fill the milled hole with epoxy up to and flush with the surface. An epoxy dispenser may be used to accurately control the application of epoxy. Remove any excess epoxy. (See Figure 3).

CAUTION

Examine milled hole to be sure all material is removed from the hole prior to filling the hole with epoxy.

NOTE

A slight overfill of epoxy may be desired to allow for shrinkage when epoxy cures.

10. Cure the epoxy per Procedure 2.7 Epoxy Mixing and Handling.

EVALUATION

1. Visual examination of cuts for spacing, and unintended damage to surrounding circuits.
2. Electrical tests as applicable.

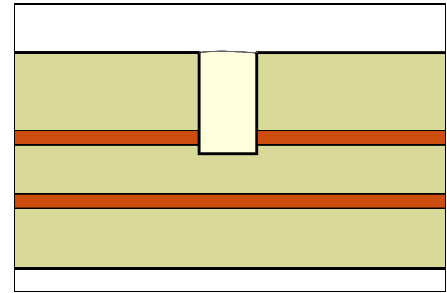

Figure 4: Completed repair.

Deleting Inner Layer Connection at a Plated Hole, Drill Through Method

Product Class: R/F ■ Skill Level: Advanced ■ Conformance Level: High

No. 4.3.3

Revision D ■ Page 1 of 2

OUTLINE

This method is used on multilayer PC boards or assemblies to disconnect an internal connection at a plated hole. A Precision Drill System is used with a carbide drill, end mill or ball mill to drill out the hole. The hole may then be filled with epoxy and redrilled to the diameter needed.

CAUTION

Extreme care must be taken to prevent damage to adjacent circuits. A microscope must be used during milling when extreme accuracy is required.

REFERENCES

- 1.0 Foreword
- 2.1 Handling Electronic Assemblies
- 2.2 Cleaning
- 2.5 Baking and Preheating
- 2.7 Epoxy Mixing and Handling

TOOLS AND MATERIALS

Cleaner
Color Agent
Continuity Meter
End Mills
Epoxy
Heat Lamp
Microscope
Oven
Pin Clamps
Precision Drill System
Tape, High Temperature
Wipes

PROCEDURE

1. Identify the hole that requires rework and clean the area.
2. Mark the coordinates on the board surface and pin the PC board in place on the base plate of the Precision Drill System. (See Figure 1).
3. Select the appropriate size end mill, drill or ball mill and insert it into the chuck of the Precision Drill System. The cutting tool should be approximately 0.50 mm (.020") greater than the plated through hole inside diameter. Set speed to high.

CAUTION

Abrasion operations can generate electrostatic charges.

NOTE

End mills are normally single end, two or four flute high grade solid carbide.

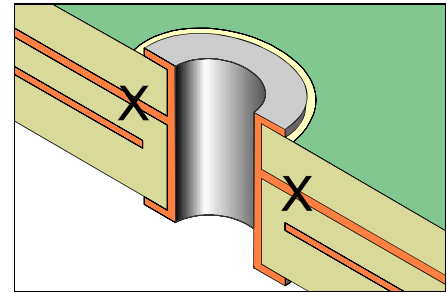

Deleting Inner Layer Connection at a Plated Hole



Figure 1: Precision Drill System with base plate to pin PC board in position while drilling out plated hole.

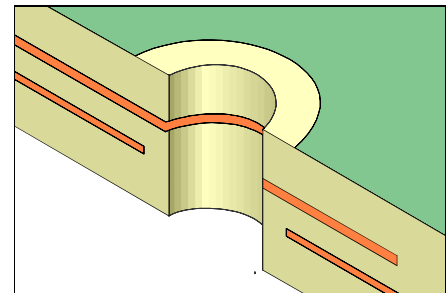

Figure 2: Completely mill through the hole to isolate the internal connection(s).

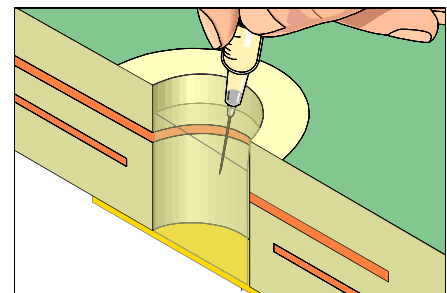

Figure 3: Fill the hole with epoxy up to and flush with the surface.

Deleting Inner Layer Connection at a Plated Hole, Drill Through Method

Product Class: R/F ■ Skill Level: Advanced ■ Conformance Level: High

Revision D ■ Page 2 of 2

4. Completely mill through the hole to isolate the internal connection(s). A microscope should be used for accuracy. (See Figure 2).
5. Blow away material with air and clean the area.
6. Check continuity to be sure that the internal connection has been deleted. Also check the continuity and inspect the neighboring circuits to make sure that none of them have been severed or damaged.

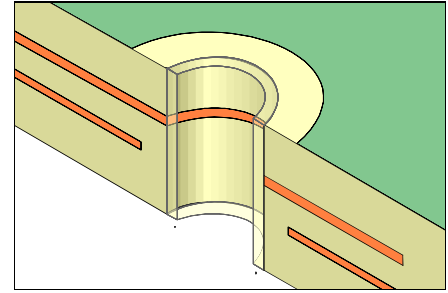

Figure 4: Completed repair.

If desired complete the following steps

7. Mask the opposite side with high temperature tape or flexible mask to prevent the epoxy from flowing out the opposite side.
8. Mix the epoxy.
9. Fill the hole with epoxy up to and flush with the surface. Remove excess epoxy. (See Figure 3).

NOTE

A slight overfill of epoxy may be desired to allow for shrinkage when epoxy cures.

10. Cure the epoxy per Procedure 2.7 Epoxy Mixing and Handling.

CAUTION

Some components may be sensitive to high temperature.

11. Clean the area.
12. Select an end mill or drill as needed. Insert the cutting tool into the Precision Drill System. Mill directly through the center of the cured epoxy. The surface pad remaining may be used as a target location for accuracy. A microscope should be used during milling for accuracy. (See Figure 4).

CAUTION

Be careful not to re-expose the internal layers of the hole when drilling out the epoxy.

13. Clean the area. Inspect the new hole using a microscope.

EVALUATION

1. Visual and electrical examination as required.

Deleting Inner Layer Connection at a Plated Hole, Spoke Cut Method

Product Class: R/F ■ Skill Level: Expert ■ Conformance Level: High

Revision D ■ Page 1 of 2

OUTLINE

This method is used on multilayer PC boards or assemblies to disconnect an internal connection at a plated hole. A precision drill press is used with a carbide end mill to make precise cuts at the spokes or internal circuits extending from the hole.

CAUTION

Extreme care must be taken to prevent damage to adjacent circuits. A microscope must be used during milling when extreme accuracy is required.

REFERENCES

- 1.0 Foreword
- 2.1 Handling Electronic Assemblies
- 2.2 Cleaning
- 2.5 Baking and Preheating
- 2.7 Epoxy Mixing and Handling

TOOLS & MATERIALS

Cleaner
Color Agent
Continuity Meter
End Mills
Epoxy
Heat Lamp
Microscope
Oven
Pin Clamps
Precision Drill System
Tape, High Temperature
Wipes

PROCEDURE

1. Identify the hole that requires rework and clean the area.
2. Mark the coordinates on the board surface and place the PC board on the base plate of the precision drill press. (See Figure 1).
3. Select the appropriate size end mill or drill and insert it into the chuck of the Precision Drill System. The cutting tool should be approximately .010 - .025 mm (.005" - .010") greater than the width of the spoke or circuit to be cut. Set speed to high.

CAUTION

Abrasion operations can generate electrostatic charges.

NOTE

End mills are normally single end, 2 or 4 four flute solid carbide.

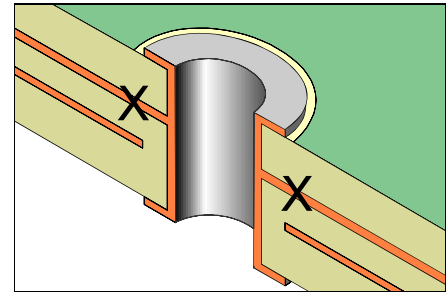

Deleting Inner layer Connection at a Plated Hole, Spoke Cut Method



Figure 1: Precision Drill System with base plate to pin PC board in position while cutting inner layers.

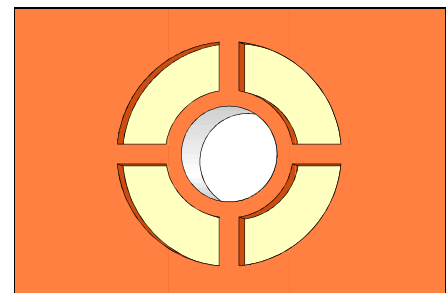

Figure 2: Internal view of plated through hole with inner layer spoke connections.

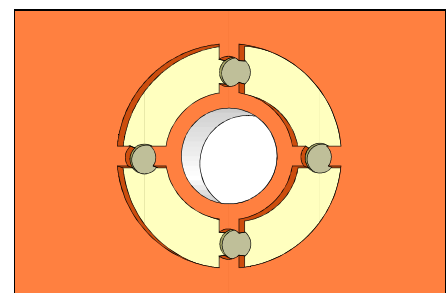

Figure 3: Mill adjacent to the plated hole to sever internal spoke connections.

Deleting Inner Layer Connection at a Plated Hole, Spoke Cut Method

No. 4.3.4

Product Class: R/F ■ Skill Level: Expert ■ Conformance Level: High

Revision D ■ Page 2 of 2

4. Mill into the PC board surface adjacent to the plated hole. The milled holes should be aligned directly above the internal spoke connections. Mill down just deep enough to sever the internal spokes connecting the plated hole to the internal plane. A microscope must be used for accuracy. Up to 4 milled holes may be required. Do not drill deeper than needed. (See Figure 3).
5. Blow away material with air and clean the area.
6. Check continuity to be sure that the internal connection has been deleted. Inspect the neighboring circuits to make sure that none of them have been severed or damaged.
7. Mix the epoxy.
8. Fill the holes with epoxy flush with the surface. Remove excess.

NOTE

A slight overfill of epoxy may be desired to allow for shrinkage.

9. Cure the epoxy per Procedure 2.7 Epoxy Mixing and Handling.

EVALUATION

1. Visual and electrical examination as required.

OUTLINE

This method is used to rebond a lifted land. Liquid epoxy is inserted under and around the land to bond it back down to the PC board surface.

REFERENCES

- 1.0 Foreword
- 2.1 Handling Electronic Assemblies
- 2.2 Cleaning
- 2.5 Baking And Preheating
- 2.7 Epoxy Mixing and Handling

TOOLS AND MATERIALS

Cleaner
Epoxy
Heat Lamp
Oven
Precision Knife
Scraper
Tape, High Temperature
Wipes

PROCEDURE

1. Clean the area.
2. Remove any obstructions that prevent the lifted land from making contact with the base board surface.

CAUTION

Be careful while cleaning and removing all obstructions, not to stretch or damage the lifted land.

3. Mix the epoxy.
4. Carefully apply a small amount of epoxy under the entire length of the lifted land. The tip of the knife or Scraper may be used to apply the epoxy. (See Figure 1).
5. Place a piece of Kapton tape over the lifted land and press the land down into the epoxy and into contact with the base board material. (See Figure 2).
6. Apply additional epoxy to the surface of the lifted land and to all sides as needed.
7. Cure the epoxy per Procedure 2.7 Epoxy Mixing and Handling.

CAUTION

Some components may be sensitive to high temperatures.

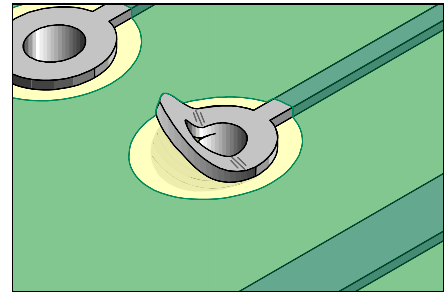

Lifted Land

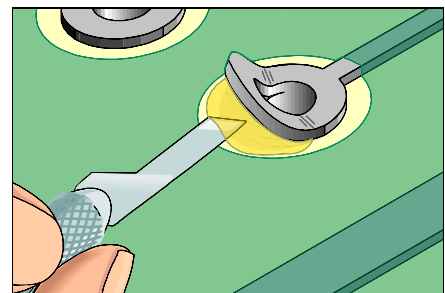

Figure 1: Carefully apply a small amount of epoxy under the entire length of the lifted land.

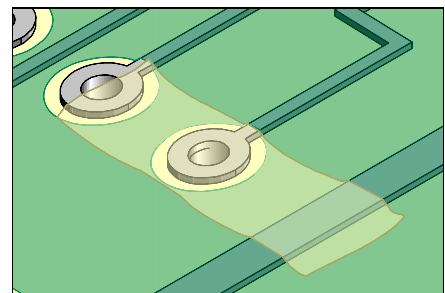

Figure 2: Place Kapton tape over the lifted land.

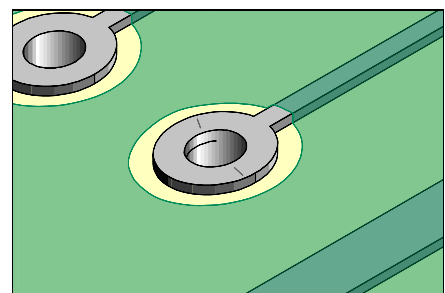

Figure 3: Completed repair.

NOTE

Double sided and multilayer PC Boards, may require an eyelet to restore the through connection. Refer to section 5.0 Plated Hole Procedures.

8. Carefully remove any excess epoxy inside the plated hole using a ball mill or drill bit. Turn the ball mill or drill bit by hand to prevent damage to the wall of the plated through hole.
9. Install the proper component and solder in place.

NOTE

This method is used to repair a lifted lands, but the repaired land may not have an intermetallic connection to the remaining plated hole. The solder joint of the replaced component will restore the integrity of the electrical connection or an eyelet or buss wire may be used. See Plated Hole Repair Procedures.

10. Replace surface coating to match prior coating as required.

EVALUATION

1. Visual examination and tape test per IPC-TM-650 test method 2.4.1. (ANSI/IPC-FC-250A)
2. Electrical tests as applicable.

OUTLINE

This method is used to repair damaged and lifted lands. The lifted lands are repaired with dry film epoxy. They are rebonded to the PC board surface using a bonding press or bonding iron.

CAUTION

It is essential that the board surface be extremely smooth and flat. If the base board is damaged see appropriate procedure.

REFERENCES

- 1.0 Foreword
- 2.1 Handling Electronic Assemblies
- 2.2 Cleaning

TOOLS & MATERIALS

Ball Mills
Bonding Film
Bonding Tip
Cleaner
Microscope
Precision Knife
Repair System
Scraper
Tape, High Temperature
Tweezers
Wipes

PROCEDURE

1. Clean the area.
2. Remove any obstructions that prevent the lifted land from making contact with the base board material.
3. Use the Surgical Knife and scrape off any epoxy residue, contamination or burned material from the board surface.
4. Clean the area.
5. Cut out a piece of bonding film that matches the area of the lifted land. Be careful not to contaminate the dry film epoxy with materials that could reduce the bond strength. (See Figure 1).

NOTE

Dry film adhesive thickness should be selected to meet the requirements of the PC Board.

6. Place the dry film under the lifted land. (See Figure 1).

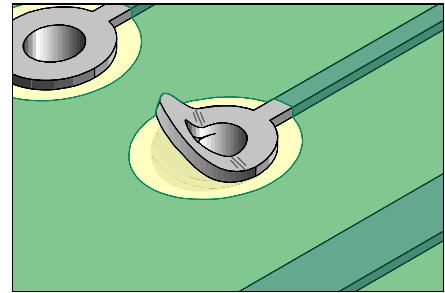

Lifted Land

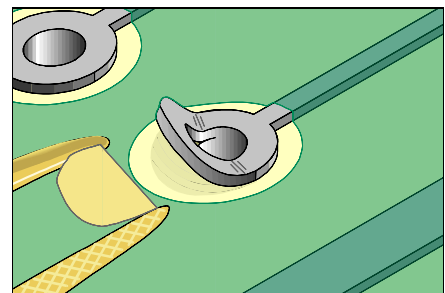

Figure 1: Cut out the appropriate shape of Bonding Film material to match the area of the lifted land.

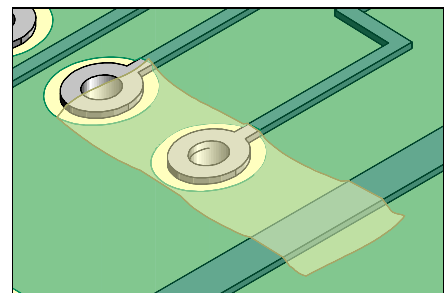

Figure 2: Place High Temperature Tape over the lifted land.



Figure 3: Bond the land down using a commercially available bonding system.

- Place a piece of High Temperature Tape over the lifted land and press the land down into contact with the adhesive film. (See Figure 2).

- Select a bonding tip with a shape to match the shape of the lifted land.

NOTE

The bonding tip should be as small as possible but should completely cover the entire surface of the new land.

- Position the PC board so that it is flat and stable. Gently place the hot bonding tip onto the tape covering the new land. Apply pressure and heat as recommended in the manual of the Repair System. (See Figure 3).

- After the bonding cycle remove the tape used for alignment. The film is fully cured. Carefully clean the area and inspect the land.

NOTE

Double sided and multilayer PC Boards, may require an eyelet to restore the through connection. Refer to section 5.0 Plated Hole Procedures.

- Carefully remove any excess bonding film inside the plated hole using a ball mill or drill bit. Turn the ball mill or drill bit by hand to prevent damage to the wall of the plated through hole.

- Install the proper component and solder in place.

NOTE

This method is used to repair a lifted land, but the repaired land may not have an intermetallic connection to the remaining plated hole. The solder joint of the replaced component will restore the integrity of the electrical connection or an eyelet or buss wire may be used. See Plated Hole Repair Procedures.

- Replace surface coating to match prior coating as required.

EVALUATION

- Visual examination and tape test per IPC-TM-650 test method 2.4.1. (ANCI/IPC-FC-250A)
- Electrical tests as applicable.

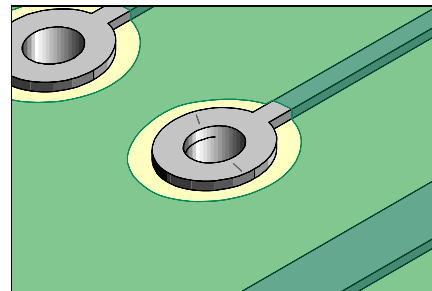

Figure 4: Completed repair.

OUTLINE

This method is used to replace damaged and lifted lands. The damaged lands are replaced with new lands. The new lands are bonded to the PC board surface using epoxy.

CAUTION

This method is used to replace a damaged or missing land, but the new land will not have an intermetallic connection to the remaining plated hole. The solder joint of the replaced component will restore the electrical connection.

CAUTION

It is essential that the board surface be smooth and flat. If the base board is damaged see appropriate procedure.

NOTE

This method uses new lands that are fabricated from copper foil. They are available in hundreds of sizes and shapes and are generally supplied solder plated. If a special size or shape is needed they can be custom fabricated.

REFERENCES

- 1.0 Foreword
- 2.1 Handling Electronic Assemblies
- 2.2 Cleaning
- 2.5 Baking And Preheating
- 2.7 Epoxy Mixing and Handling

TOOLS & MATERIALS

Buffer
Circuit Frames, Lands
Cleaner
Convection Oven
Epoxy
Flux, Liquid
Heat Lamp
Microscope
Precision Knife
Repair System or Repair Kit
Scraper
Solder
Soldering Iron
Tape, High Temperature
Tweezers
Wipes

PROCEDURE

1. Clean the area.

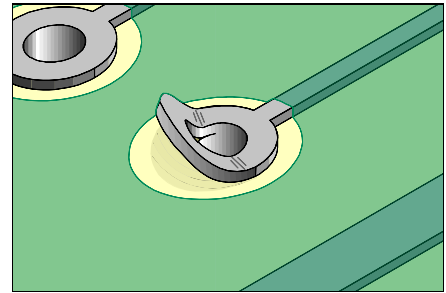

Damaged Land

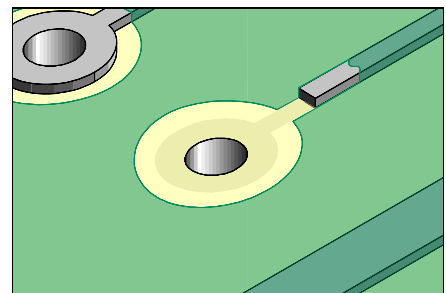

Figure 1: Remove the defective land and remove soldermask from the connecting circuit.

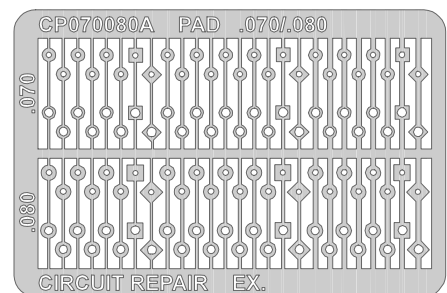

Figure 2: Select a replacement land that matches the missing land.

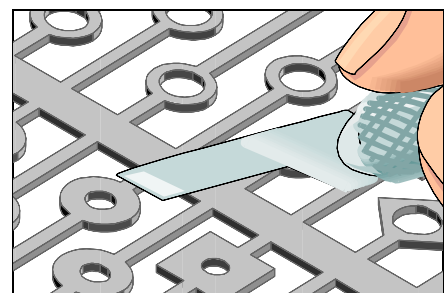

Figure 3: Cut out the replacement land.

2. Remove the defective land and a short length of the connecting circuit if any. (See Figure 1).
3. Use the Precision Knife and scrape off any epoxy residue, contamination or burned material from the board surface.

CAUTION

Abrasion operations can generate electrostatic charges.

4. Scrape off any solder mask or coating from the connecting circuit. (See Figure 1).
5. Clean the area.
6. Apply a small amount of liquid flux to the connection area on the board surface and tin with solder. Clean the area. The length of the overlap solder connection should be a minimum of 2 times the circuit width.
7. The area for the new pad on the board surface must be smooth and flat. If internal fibers of the board are exposed or if there are deep scratches in the surface they should be repaired. Refer to appropriate procedure.
8. Select a replacement land that most closely matches the land to be replaced. (See Figure 2).
9. Cut out and trim the new land. Cut the length to provide the maximum allowable circuit overlap for soldering. Minimum 2 times the circuit width. (See Figure 3).

NOTE

The new replacement land may be trimmed from copper sheet.

10. Mix the epoxy and apply a small amount to the surface where the new land will be placed.
11. Place a piece of Kapton tape over the top surface of the land. Place the new land into position on the PC board surface using the tape to aid in alignment. (See Figure 4).
12. Cure the epoxy per Procedure 2.7 Epoxy Mixing and Handling.
13. After the epoxy has cured, remove the tape used for the alignment. Carefully clean the area and inspect the new land for proper alignment.
14. If the new land has a connecting circuit apply a small amount of liquid flux to the lap solder joint connection area and solder the circuit from the new land to the circuit on the PC board surface. Use minimal flux and solder to ensure a reliable connection. Tape may be placed over the top of the new land to prevent excess solder.

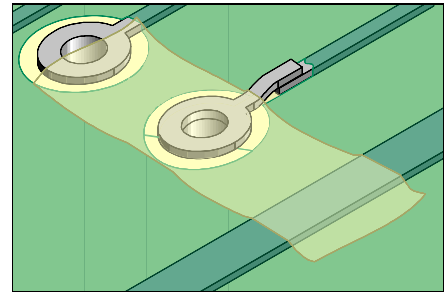

Figure 4: Place the new land in place using Kapton tape.

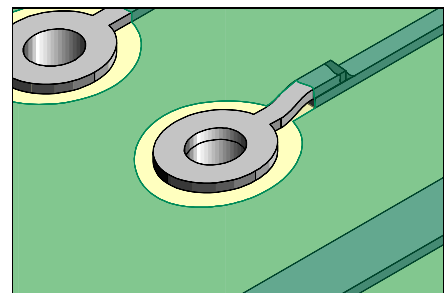

Figure 5: Completed repair.

NOTE

If the configuration permits, the overlap solder joint connection should be a minimum of 3.00 mm (0.125") from the related termination. This gap will minimize the possibility of simultaneous reflow during soldering operations. Refer to 7.1 Soldering Basics.

15. Remove tape and clean the area.
16. Mix the epoxy and coat the lap solder joint connections. Cure the epoxy per Procedure 2.7 Epoxy Mixing and Handling.

NOTE

Additional epoxy can be applied around the perimeter of the new land to provide additional bond strength.

CAUTION

Some components may be sensitive to high temperature.

17. Carefully remove any excess epoxy inside the plated hole using a ball mill or drill bit. Turn the ball mill or drill bit by hand to prevent damage to the wall of the plated through hole.
18. Install the proper component and solder in place.

NOTE

This method is used to replace a damaged or missing lands, but the new land will not have an intermetallic connection to the remaining plated hole. The solder joint of the replaced component will restore the integrity of the electrical connection or an eyelet or buss wire may be used. See Plated Hole Repair Procedures.

19. Apply surface coating to match prior coating as required.

EVALUATION

1. Visual examination
2. Measurement of new pad width and spacing.
3. Electrical continuity measurement.

OUTLINE

This method is used to replace damaged and lifted lands. The damaged lands are replaced with new dry film, adhesive backed lands. The new lands are bonded to the PC board surface using a bonding press or bonding iron.

CAUTION

This method is used to replace a damaged or missing land, but the new land will not have an intermetallic connection to the remaining plated hole. The solder joint of the replaced component will restore the integrity of the electrical connection.

CAUTION

It is essential that the board surface be smooth and flat. If the base board is damaged see appropriate procedure.

NOTE

This method uses new lands that are fabricated from copper foil and have a dry film adhesive coating on the back. They are available in hundreds of sizes and shapes and are generally supplied solder plated. If a special size or shape is needed they can be custom fabricated.

REFERENCES

- 1.0 Foreword
- 2.1 Handling Electronic Assemblies
- 2.2 Cleaning
- 2.5 Baking And Preheating
- 2.7 Epoxy Mixing and Handling

TOOLS & MATERIALS

- Bonding Iron
- Bonding Tips
- Bonding System
- Buffer
- Circuit Frames, Lands
- Cleaner
- Epoxy
- Flux, Liquid
- Heat Lamp
- Microscope
- Precision Knife
- Repair System
- Scraper
- Solder
- Soldering Iron
- Tape, High Temperature
- Tweezers
- Wipes

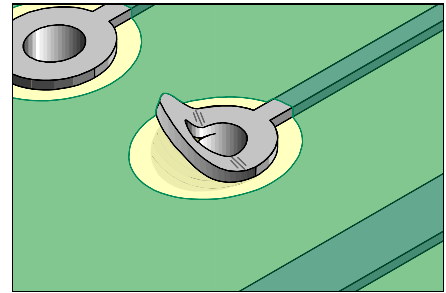

Damaged Land

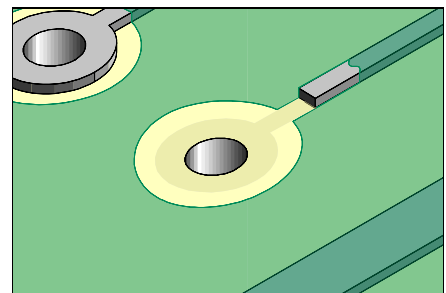

Figure 1: Remove the defective land and remove soldermask from the connecting circuit.

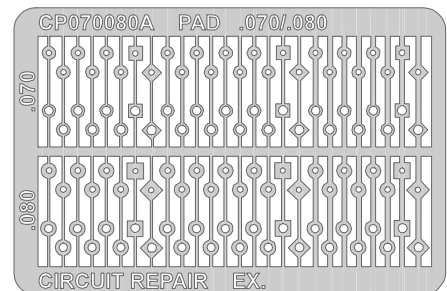

Figure 2: Select a replacement land that matches the missing land.

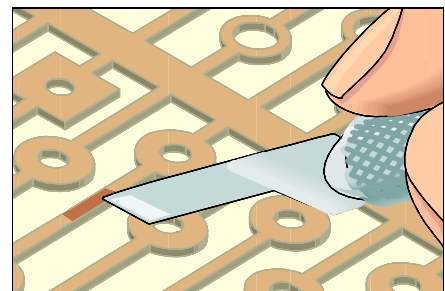

Figure 3: Scrape off the adhesive bonding film from solder joint area on the back of new land.

PROCEDURE

1. Clean the area.
2. Remove the defective land and a short length of the connecting circuit if any. (See Figure 1).
3. Use the knife and scrape off any epoxy residue, contamination or burned material from the board surface.

CAUTION

Abrasion operations can generate electrostatic charges.

4. Scrape off any solder mask or coating from the connecting circuit. (See Figure 1).
5. Clean the area.
6. Apply a small amount of liquid flux to the connection area on the board surface and tin with solder. Clean the area. The length of the overlap solder connection should be a minimum of 2 times the circuit width.
7. The area for the new pad on the board surface must be smooth and flat. If internal fibers of the board are exposed or if there are deep scratches in the surface they should be repaired. Refer to appropriate procedure.
8. Select a replacement land that most closely matches the land to be replaced. (See Figure 2).

NOTE

The new replacement land may be trimmed from copper sheet.

9. Before trimming out the new land carefully scrape off the adhesive film from the solder joint connection area on the back of the new land. (See Figure 3).

CAUTION

Scrape off the epoxy backing only from the joint connection area. When handling the replacement land avoid touching the adhesive backing with your fingers or other materials that may contaminate the surface and reduce the bond strength.

10. Cut out and trim the new land. Cut out from the plated side. Cut the length to provide the maximum allowable circuit overlap for soldering. Minimum 2 times the circuit width. (See Figure 4).
11. Place a piece of High Temperature Tape over the top surface of the new land. Place the new land into position on the PC board surface using the High Temperature Tape to aid in alignment. Leave the High Temperature Tape in place during the bonding cycle. (See Figure 5).

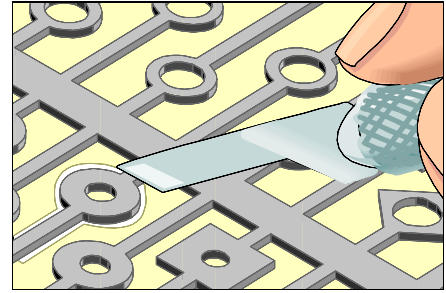

Figure 4: Cut out the new land. Cut from the plated side.

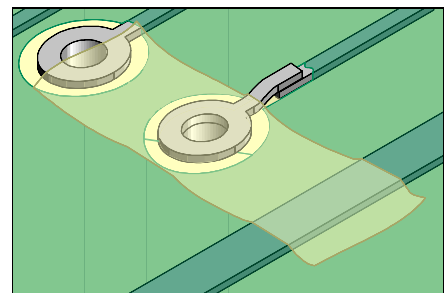

Figure 5: Place the new land in place using High Temperature Tape.



Figure 6: Bond the new land with a Bonding System.

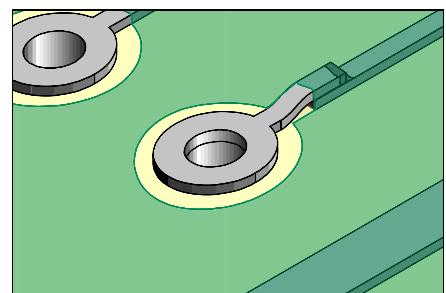

Figure 7: Completed land repair.

12. Select a bonding tip with a shape to match the shape of the new land.

NOTE

The Bonding Tip should be as small as possible but should completely cover the entire surface of the new land.

13. Position the PC board so that it is flat and stable. Gently place the hot bonding tip onto the High Temperature Tape covering the new land. Apply pressure as recommended in the manual of the repair system or repair kit of the manufacturer. (See Figure 6).

CAUTION

Excessive bonding pressure may cause measling in the PC board surface or the new circuit to slide out of position.

14. After the bonding cycle remove the High Temperature Tape used for alignment. The land is fully cured. Carefully clean the area and inspect the new land for proper alignment.
15. If the new land has a connecting circuit apply a small amount of liquid flux to the lap solder joint connection area and solder the circuit from the new land to the circuit on the PC board surface. Use minimal flux and solder to ensure a reliable connection. High Temperature Tape may be placed over the top of the new land to prevent excess solder overflow.

NOTE

If the configuration permits, the overlap solder joint connection should be a minimum of 3.00 mm (0.125") from the related termination. This gap will minimize the possibility of simultaneous reflow during soldering operations. Refer to 7.1 Soldering Basics.

16. Remove tape and clean the area.
17. Mix epoxy and coat the lap solder joint connections. Cure the epoxy per Procedure 2.7 Epoxy Mixing and Handling.

NOTE

Additional epoxy can be applied around the perimeter of the new pad to provide additional bond strength.

CAUTION

Some components may be sensitive to high temperature.

18. Carefully remove any excess bonding film inside the plated hole using ball mill or drill bit. Turn the ball mill or drill bit by hand to prevent damage to the wall of the plated through hole.
19. Install the proper component and solder in place.

NOTE

This method is used to replace a damaged or missing land, but the new land will not have an intermetallic connection to the remaining plated hole. The solder joint of the replaced component will restore the integrity of the electrical connection or an eyelet or buss wire may

be used. See Plated Hole Repair Procedures.

20. Apply surface coating to match prior coating as required.

EVALUATION

1. Visual examination
2. Measurement of new pad width and spacing.
3. Electrical continuity measurement.

OUTLINE

This method is used to replace a damaged edge contact with a new edge contact. The new edge contact is bonded to the PC board surface using liquid epoxy.

CAUTION

It is essential that the board surface be smooth and flat. If the base material is damaged see appropriate procedure.

NOTE

This method uses replacement edge contacts that are fabricated from copper foil. They are available in hundreds of sizes and shapes and are generally supplied either plain copper, solder plated or nickel and gold plated. If a special size or shape is needed they can be custom fabricated.

REFERENCES

- 1.0 Foreword
- 2.1 Handling Electronic Assemblies
- 2.2 Cleaning
- 2.5 Baking And Preheating
- 2.7 Epoxy Mixing and Handling

TOOLS & MATERIALS

- Circuit Frame,
- Edge Contacts
- Cleaner
- Epoxy
- Finishing File
- Heat Lamp
- Tape, High Temperature
- Flux, Liquid
- Microscope
- Oven
- Tweezers
- Solder
- Soldering Iron
- Precision Knife
- Scraper
- Wipes

PROCEDURE

1. Clean the area.
2. Remove the defective edge contact and a short length of the connecting circuit. Heat from a soldering iron will allow the old contact to be removed more easily. (See Figure 1).

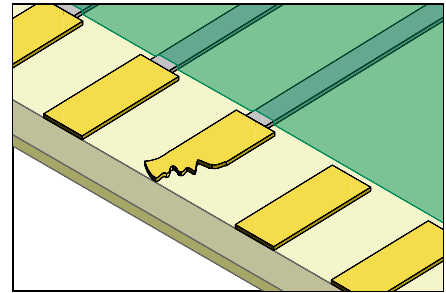

Damaged Edge Contact

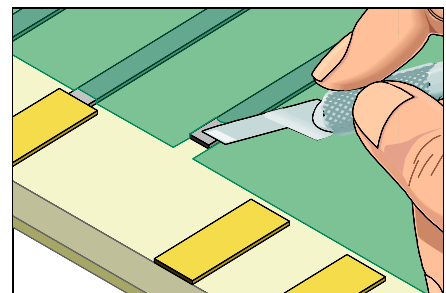

Figure 1: Remove the defective edge contact and remove solder mask from the connecting circuit.

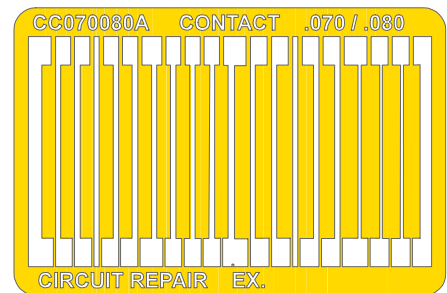

Figure 2: Select a replacement contact that matches the missing contact.

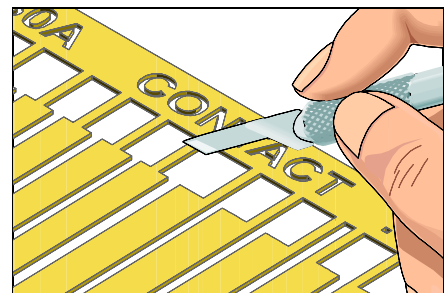

Figure 3: Cut out the new edge contact.

3. Use the knife and scrape off any epoxy residue, contamination or burned material from the board surface.

CAUTION

Abrasion operations can generate electrostatic charges.

4. Scrape off any solder mask or coating from the connecting circuit. (See Figure 1).
5. Clean the area.
6. Apply a small amount of liquid flux to the connection area on the board surface and tin with solder. Clean the area. The length of the overlap solder connection should be a minimum of 2 times the circuit width.
7. The area for the new edge contact on the board surface must be smooth and flat. If internal fibers of the board are exposed or deep scratches exist in the surface they should be repaired. Refer to appropriate procedure.
8. Select a new edge contact that most closely matches the edge contact to be replaced. (See Figure 2).

9. Cut out and trim the new edge contact. Cut out from the plated side. Cut the length to provide the maximum allowable joint if lap soldering. Minimum 2 times the circuit width. Leave the new edge contact extra long. The excess material will be trimmed after curing. (See Figure 3).

NOTE

The new replacement edge contact may be trimmed from copper sheet.

10. Mix the epoxy and apply a small amount to the surface where the new contact will be placed.
11. Place a piece of Kapton tape over the top surface of the new edge contact. Position the new edge contact on the PC board surface using the Kapton tape to aid in alignment. (See Figure 4).

NOTE

Allow the edge contact to overhang the edge of the PC board. Leave the Kapton tape in place during the bonding cycle.

12. Cure the epoxy per Procedure 2.7 Epoxy Mixing and Handling.

CAUTION

Some components may be sensitive to high temperature.

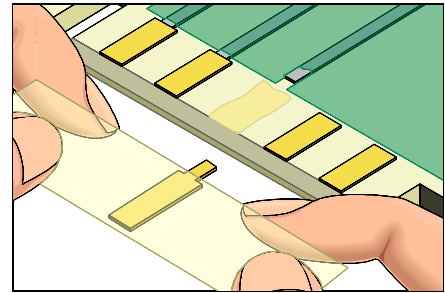

Figure 4: Place the new edge contact in place using Kapton tape.

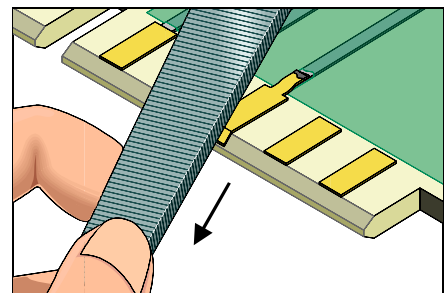

Figure 5: File overhanging piece of new edge contact to blend with existing bevel.

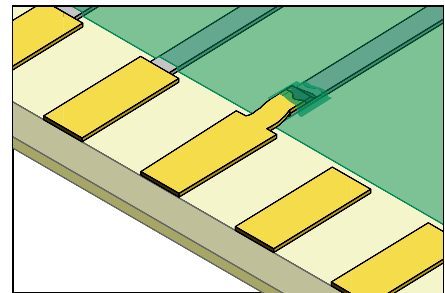

Figure 6: Completed repair.

13. After the epoxy has cured, remove the Kapton tape used for alignment. Carefully clean and inspect the new pad for proper alignment.

NOTE

Additional epoxy can be applied around the perimeter of the new edge contact to provide additional bond strength.

14. If the new edge contact has a connecting circuit apply a small amount of liquid flux to the lap solder joint connection area and solder the circuit from the new edge contact to the circuit on the PC board surface. Use minimal flux and solder to ensure a reliable connection. Kapton tape may be placed over the top of the new edge contact to prevent excess solder overflow.

NOTE

If the configuration permits, the overlap solder joint connection should be a minimum of 3.00 mm (0.125") from the related termination. This gap will minimize the possibility of simultaneous reflow during soldering operations. Refer to 7.1 Soldering Basics.

15. Remove the Kapton tape and clean the area.
16. Trim the extending edge of the new edge contact with a file. File parallel to the beveled edge until the excess material has been removed. (See Figure 5).
17. If sealing the lap solder joint connection is required, mix epoxy and coat the lap solder joint connections. Cure the epoxy per Procedure 2.7 Epoxy Mixing and Handling.
18. If plating is required refer to appropriate procedure.
19. Apply surface coating to match prior coating as required.

EVALUATION

1. Visual examination, measurement of new pad width and spacing.
2. Electrical continuity measurement.

OUTLINE

This method is used to replace a damaged edge contact with a new dry film, adhesive backed edge contact. The new edge contact is hot bonded to the PC board surface using a bonding iron or bonding press.

CAUTION

It is essential that the board surface be smooth and flat. If the base material is damaged see appropriate procedure.

NOTE

This method uses replacement edge contacts that are fabricated from copper foil and have a dry film adhesive coating on the back. They are available in hundreds of sizes and shapes and are generally supplied nickel and gold plated. If a special size or shape is needed they can be custom fabricated.

REFERENCES

- 1.0 Foreword
- 2.1 Handling Electronic Assemblies
- 2.2 Cleaning
- 2.5 Baking And Preheating
- 2.7 Epoxy Mixing and Handling

TOOLS & MATERIALS

- Bonding Iron
- Bonding Tip
- Bonding System
- Circuit Frames
- Cleaner
- Epoxy
- Finishing File
- Flux, Liquid
- Heat Lamp
- Microscope
- Oven
- Precision Knife
- Repair System
- Scraper
- Solder
- Soldering Iron
- Tape, High Temperature
- Tweezers
- Wipes

PROCEDURE

1. Clean the area.

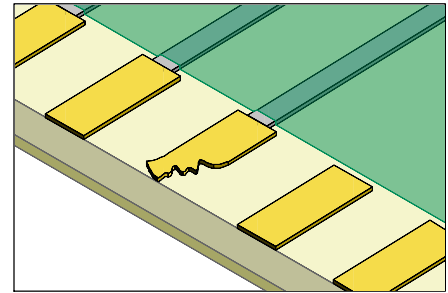

Damaged Edge Contact

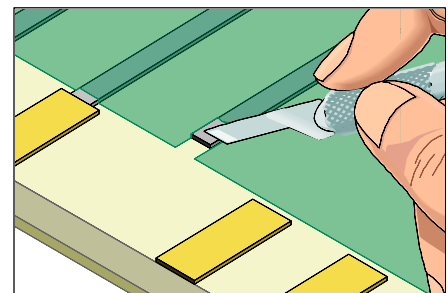

Figure 1: Remove the defective edge contact and remove solder mask from the connecting circuit.

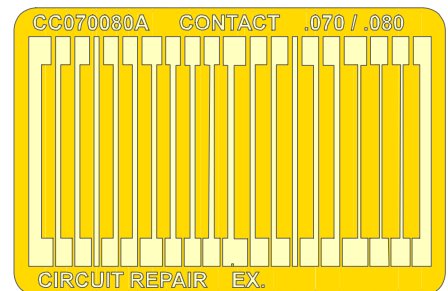

Figure 2: Select a replacement contact that matches the missing contact.

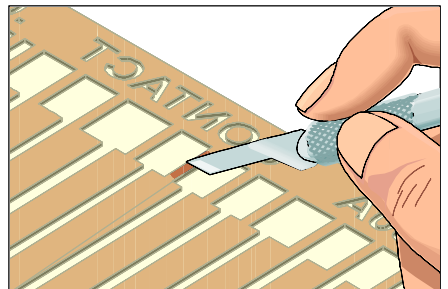

Figure 3: Scrape off the adhesive bonding film from the solder joint area on the back of new contact.

2. Remove the defective edge contact and a short length of the connecting circuit. Heat from a soldering iron will allow the old contact to be removed more easily. (See Figure 1).
3. Use the knife and scrape off any epoxy residue, contamination or burned material from the board surface.

CAUTION

Abrasion operations can generate electrostatic charges.

4. Scrape off any solder mask or coating from the connecting circuit. (See Figure 1).
5. Clean the area.
6. Apply a small amount of liquid flux to the connection area on the board surface and tin with solder. Clean the area. The length of the overlap solder connection should be a minimum of 2 times the circuit width.
7. The area for the new edge contact on the board surface must be smooth and flat. If internal fibers of the board are exposed or deep scratches exist in the surface they should be repaired. Refer to appropriate procedure.
8. Select a new edge contact that most closely matches the edge contact to be replaced. (See Figure 2).

NOTE

The new replacement edge contact may be trimmed from copper sheet.

9. Before trimming out the new edge contact carefully scrape off the adhesive film from the solder joint connection area on the back of the new edge contact. (See Figure 3).

CAUTION

Scrape off the epoxy backing only from the joint connection area. When handling the replacement contact, avoid touching the epoxy backing with your fingers or other materials that may contaminate the surface and reduce the bond strength.

10. Cut out and trim the new edge contact. Cut out from the plated side. Cut the length to provide the maximum allowable joint if lap soldering. Minimum 2 times the circuit width. Leave the new edge contact extra long. The excess material will be trimmed after bonding. (See Figure 4).
11. Place a piece of tape over the top surface of the new edge contact. Position the new edge contact on the PC board surface using the tape to aid in alignment. (See Figure 5).

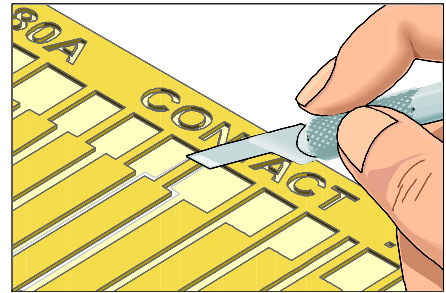

Figure 4: Cut out the new edge contact. Cut from the plated side.

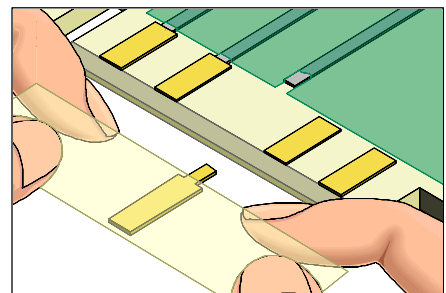

Figure 5: Place the new edge contact in place using Kapton tape.



Figure 6: Bond the new edge contact with a Bonding System.

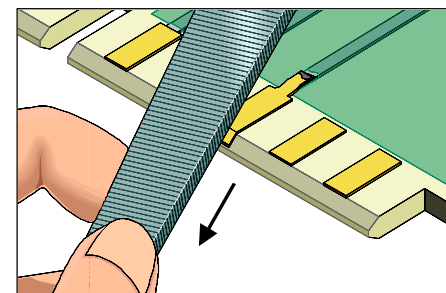

Figure 7: File overhanging piece of the new edge contact to blend with existing bevel.

NOTE

Allow the edge contact to overhang the edge of the PC board. Leave the Tape in place during the bonding cycle.

12. Select a bonding tip with a shape to match the shape of the new edge contact.

NOTE

The bonding tip should be as small as possible but completely cover the entire surface of the new edge contact.

13. Position the PC board so that it is flat and stable. Gently place the hot bonding tip onto the tape covering the new edge contact. Apply pressure as recommended by the manufacturer. (See Figure 6).

CAUTION

Excessive bonding pressure may cause measling in the PC board surface or the new circuit to slide out of position.

14. After the bonding cycle remove the High Temperature Tape used for alignment. The new edge contact is fully cured. Carefully clean the area and inspect the new edge contact for proper alignment.
15. If the new edge contact has a connecting circuit apply a small amount of liquid flux to the lap solder joint connection area and solder the circuit from the new edge contact to the circuit on the PC board surface. Use minimal flux and solder to ensure a reliable connection. Tape may be placed over the top of the new edge contact to prevent excess solder overflow.

NOTE

If the configuration permits, the overlap solder joint connection should be a minimum of 3.00 mm (0.125") from the related termination. This gap will minimize the possibility of simultaneous reflow during soldering operations. Refer to 7.1 Soldering Basics.

16. Remove the High Temperature Tape and clean the area.
17. Trim the extending edge of the new edge contact with a file. File parallel to the beveled edge until the excess material has been removed. (See Figure 7).
18. If sealing the lap solder joint connection is required, mix epoxy and coat the lap solder joint connections. Cure the epoxy per Procedure 2.7 Epoxy Mixing and Handling.

CAUTION

Some components may be sensitive to high temperature.

NOTE

Additional epoxy can be applied around the perimeter of the new edge contact to provide additional bond strength.

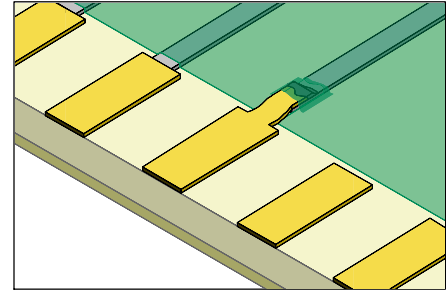

Figure 9: Completed repair.

19. Apply surface coating to match prior coating as required.

EVALUATION

1. Visual examination, measurement of new pad width and spacing.
2. Electrical continuity measurement.

OUTLINE

This method is used to replate edge contacts by selective swab plating. Edge contacts may require replating if they become contaminated with solder or are scratched during handling. Other applications may arise when the plating on the edge contacts does not meet the minimum thickness specification or if the specification changes.

This electroplating process uses a DC power supply. One lead is connected to the connector edge contacts that need plating. A second lead is connected to the plating probe. The plating probe has an anode fastened to the tip. The anode has absorbent wrapping. The anode is dipped into high-speed proprietary plating solutions. When the saturated anode is swabbed across the PC board connector edge contacts, the metal contained in the solution is plated wherever electrical contact is made. Prior to replating any solder contamination must be removed.

CAUTION

This method can be used to replate any metal surface including connector edge contacts, but it is essential that the surface to be plated is free of deep scratches, nicks, pin holes or other defects. If the edge contacts need to be replaced see appropriate procedure.

SAFETY

A thorough review of this method should be made before repairs are attempted. Technicians should become familiar with the tools included and should practice on scrap PC boards

To expect the best results a clean work environment is essential. A smooth work surface and good lighting are recommended. Safety glasses and safety gloves should always be worn when handling hazardous chemicals.

The work area should be adequately ventilated. It is particularly important to have adequate ventilation when using gold solution, since gold solution contains a very small percentage of free cyanide. If ventilation is not adequate, use a fan to move fumes away from the operator.

CAUTION

It is essential to follow the manufacturer's instruction supplied with the plating equipment.

REFERENCES

- 1.0 Foreword
- 2.1 Handling Electronic Assemblies
- 2.2 Cleaning

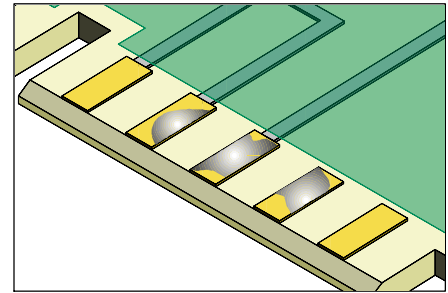

Contaminated Gold Edge Contacts



Figure 1: Connector Edge Plating System.

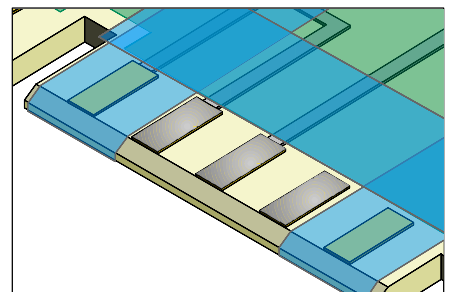

Figure 2: Flow solder over the entire surface of each contaminated contact.

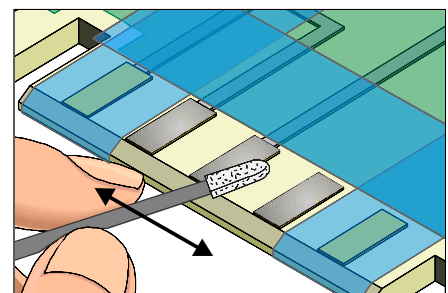

Figure 3: Swab the contaminated area with solder stripping solution until all solder has been removed.

TOOLS & MATERIALS

Abrasive Pad
Board Support
Burnisher
Cleaner
Conductive Pen
Connector Edge Plating System
Desoldering Braid or Desoldering System
Eraser Stick
Flux, Liquid
Gloves, Antistatic
Peel Testing Tape
Pin Fixtures
Plating Anodes
Plating Solution, Gold
Plating Probe
Plating Solution, Electroclean
Plating Cables
Plating Solution, Nickel
Plating Solution, Solder Strip
Plating Tape
Power Supply
Precision Knife
Probe Clip
Rinse Tray
Rinse Bottle
Safety Glasses
Solder Iron
Solder
Solution Swab
Solution Cups
Solution Tray
Tape, High Temperature
Thickness Measuring System, Gold and Nickel
Water/Air Sprayer
Wipes
Wire, Bus, 30 AWG
Work Sink

PREPARATION - Remove Solder Contamination

CAUTION

Safety glasses and safety gloves should always be worn when handling hazardous chemicals. Do not work within a small enclosed room without supplemental ventilation. If ventilation is not adequate, use a fan to move fumes away from the operator.

1. Clean the rework area.

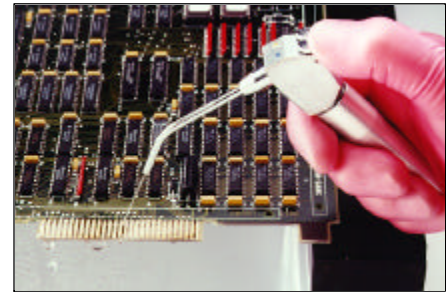

Figure 4: Rinse the area with water. A water/air sprayer provides a full water flush.

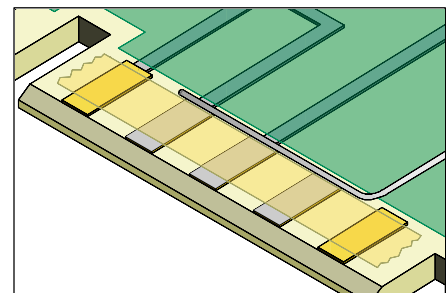

Figure 5: Apply High Temperature Tape then solder a wire to the edge of the contacts needing plating.

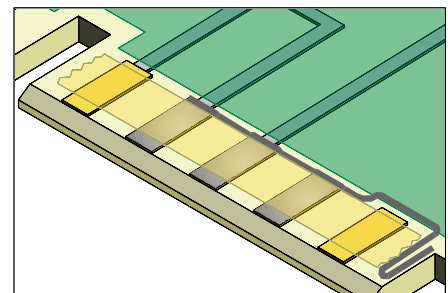

Figure 6: Apply High Temperature Tape then apply conductive paint to the contacts that need plating.

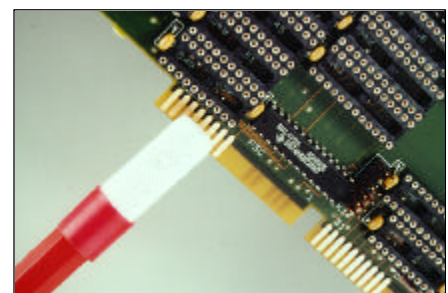

Figure 7: Sample plating anodes shown with fabric wrapping.

2. Apply plating tape to the PC board surface surrounding the area to be reworked. The plating tape will protect adjacent components and the PC board surface from unwanted exposure to stripping and plating solutions.
3. Flow solder over the entire area of any contacts that have contamination using a soldering iron. This provides a more even surface when plating. Remove the bulk of the solder contamination using desoldering tools or desoldering braid. (See Figure 2).
4. Clean the area.
5. Place the PC board on the board support so that the leading edge overhangs the rinse tray.
6. Swab the solder stripping solution over the solder contamination using a swab. Swab the surface until all remaining solder has been stripped off. (See Figure 3).
7. Thoroughly rinse the entire area with water. (See Figure 4).
8. Mildly buff the contacts using abrasive pad. Mild buffing will prepare the surface for plating and remove any remaining solder contamination.
9. Thoroughly rinse with water to remove any residue.

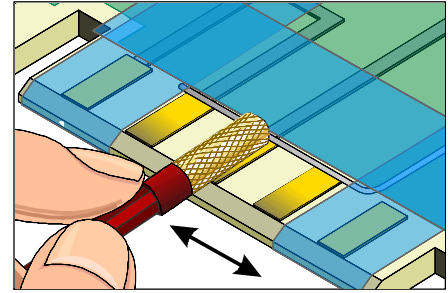

Figure 8: Swab all the contacts by brushing the surface with the saturated plating probe.

PREPARATION - Remove Poor Plating or Surface Defects

1. Clean the rework area.
2. Apply plating tape to the PC board surface surrounding the area to be reworked. The plating tape will protect adjacent components and the PC board surface from unwanted exposure to stripping and plating solutions.
3. Clean the area.
4. Buff the contacts using an abrasive pad. Buff the contacts until all defective or poor plating is removed.
5. Burnish small scratches. Use the tip of the Tech-Pro Burnisher to work the copper material into the scratch and smooth out the area. Finish by mildly buffing the area to remove any minor burnishing marks. If there are large scratches the contact may need replacement. See Procedure Number 4.6.1 or 4.6.2.
6. Thoroughly rinse the entire area with water to remove any residue.

BUSING

A conductive bus must be made to all the contacts that need plating. There are 4 basic connection options.

NOTE

Making a reliable bus connection is the most important step in plating. All sorts of problems will be eliminated by taking the time to make a reliable bus connection.

BUSING - Wire Soldered to Edge (Option 1)

CAUTION

When finished, this method will leave a small unplated line along the inner tip of each contact.

1. Apply High Temperature Tape to all the contacts to be plated. The High Temperature Tape should cover the entire contact except for a small line along the inboard edge. The High Temperature Tape will prevent further solder contamination.
2. Solder a wire directly to the inboard tip or connecting circuit of each contact to be plated. The smallest amount of solder should be used to prevent further contamination. (See Figure 5).

BUSING - Conductive Paint Applied to Edge (Option 2)

CAUTION

When finished, this method will leave a small unplated line along the inner tip of each contact.

1. Apply High Temperature Tape to all the contacts to be plated. The High Temperature Tape should cover the entire contact except for a small line along the inboard edge. The High Temperature Tape will prevent the conductive paint from contaminating the contact surface.
2. Apply a thin coating of conductive paint directly to the inboard tip of each contact to be plated. The conductive paint should extend out to one edge so that a clip can be applied to make electrical connection. (See Figure 6).

BUSING - Mechanical Probe, Individual Contacts (Option 3)

1. Each contact needing plating can be individually probed using the plating probe. Touch the tip of the plating probe to the inboard edge of each contact or to the connecting circuit as each solution is applied during the plating process.

BUSING - Pin Fixture, Multiple Contacts (Option 4)

1. Make a mechanical connection to each contact using a pin fixture. The pin fixture has spring loaded contact pins on centers matching the spacing of the edge contacts to be plated. The contact pins make direct mechanical connection to the inboard tip of each

contact, the connecting circuit trace or a connecting plated through hole.

PROCEDURE - Plating Process

1. Place the PC board on the board support so that the leading edge overhangs the rinse tray.
2. Make the cathode connection (-) to the PC board by using a plating probe or probe clip. Connect the probe clip directly to the wire bus connection or to the edge where conductive paint has been applied. The cable should be connected to the (-) or black jack on the power supply.
3. Connect the plating probe to the power supply (+) or red jack. (See Figure 7).
4. Set the output current on the power supply to setting recommended by the equipment manufacturer. Refer to Table 1 for general voltage/time settings.
5. Dip the plating probe into the electroclean plating solution. Wait a few seconds for the solution to saturate the absorbent wrapping.
6. Swab the entire surface to be plated by brushing the surface with the saturated plating probe. The plating probe should be moved back and forth briskly to prevent burning and to provide even coverage. (See Figure 8) Swab the area for the time recommended by the equipment manufacturer. Refer to Table 1 for general voltage/time settings.
7. Thoroughly rinse the entire area with water. Any burning or darkening of the contacts may be removed with an abrasive pad. Saturate the abrasive pad and the PC board surface with water and lightly buff the contacts until all evidence of the burning or discoloring is removed. Rinse the entire area with water.

CAUTION

Do not allow the rework area to dry out between steps. The water coating prevents oxidation.

8. Connect the nickel plating probe to the power supply (+) or red jack.
9. Set the output current on the power supply to setting recommended by the equipment manufacturer. Refer to Table 1 for general voltage/time settings.
10. Dip the plating probe into the nickel plating solution. Wait a few seconds for the solution to saturate the absorbent wrapping.
11. Swab the entire surface to be plated by brushing the surface with the saturated plating probe. The plating probe should be moved back and forth briskly to prevent burning and to provide even coverage. Swab the area for the time recommended by the equipment

manufacturer. Before rinsing, lightly buff the contacts with an abrasive pad. Refer to Table 1 for general voltage/time settings.

12. Thoroughly rinse the entire area with water.
13. Connect the gold plating probe to the power supply (+) or red jack.
14. Set the output current on the power supply to setting recommended by the equipment manufacturer. Refer to Table 1 for general voltage/time settings.
15. Dip the plating probe into the gold plating solution. Wait a few seconds for the solution to saturate the absorbent wrapping.
16. Swab the entire surface to be plated by brushing the surface with the saturated plating probe. The plating probe should be moved back and forth briskly to prevent burning and to provide even coverage. Swab the area for the time recommended by the equipment manufacturer. Refer to Table 1 for general voltage/time settings.
17. Thoroughly rinse the entire area with water.
18. Remove and discard all plating tape and thoroughly rinse the area with water. Dry the area using a water/air sprayer or wipes.
19. Remove the wire or conductive paint used to bus the contacts.

CAUTION

Apply High Temperature Tape to protect the contacts from further contamination while removing the bus connection.

20. Thoroughly rinse the entire area with deionized water or rinse the PC board in an aqueous water cleaning system.

**Table 1
Typical Voltage/Time Settings**

Surface Area	Electroclean		Nickel		Gold	
	Volts	Time	Volts	Time	Volts	Time
<.01 in ²	10.0 VDC	5 sec.	4.0 VDC	10 sec.	3.0 VDC	10 sec.
.01 - .05 in ²	10.0 VDC	5 sec.	4.0 VDC	30 sec.	3.5 VDC	20 sec.
.05 - .10 in ²	10.0 VDC	5 sec.	4.0 VDC	1.0 min.	4.0 VDC	30 sec.
.10 - .20 in ²	10.0 VDC	10 sec.	4.0 VDC	2.0 min.	4.0 VDC	1.0 min.
.20 - .30 in ²	10.0 VDC	10 sec.	4.0 VDC	2.5 min.	4.0 VDC	1.5 min.
.30 - .40 in ²	10.0 VDC	10 sec.	4.0 VDC	3.0 min.	4.0 VDC	2.0 min.
.40 - .50 in ²	10.0 VDC	20 sec.	4.0 VDC	4.0 min.	4.0 VDC	2.5 min.
.50 - .60 in ²	10.0 VDC	20 sec.	5.0 VDC	5.0 min.	4.0 VDC	3.0 min.
.60 - .70 in ²	10.0 VDC	20 sec.	6.0 VDC	6.0 min.	4.0 VDC	3.5 min.
.70 - .80 in ²	10.0 VDC	30 sec.	6.0 VDC	7.0 min.	4.0 VDC	4.0 min.
.80 - .90 in ²	10.0 VDC	30 sec.	6.0 VDC	7.5 min.	4.0 VDC	4.5 min.
.90 - 1.00 in ²	10.0 VDC	30 sec.	6.0 VDC	8.0 min.	4.0 VDC	5.0 min.

Notes:

1. Surface Area is the total area being plated during each swab plating operation.
2. Voltage and Time setting shown in Table 1 are for a minimum of .000100" Nickel and .000050" Gold.
3. Setting are a guide, for precise thickness requirements the final thickness should be verified with proper measuring equipment.

EVALUATION

1. The rework area should be checked by measuring the thickness of the nickel and gold to make sure they meet the minimum thickness requirement.
2. The plating bond may also be checked by doing a peel test using peel testing tape.
3. Visually examine the rework area for color and luster.

OUTLINE

This method is used to replace damaged surface mount pads with commercially available replacement pads. The new pads are bonded to the PC board surface using liquid epoxy.

CAUTION

It is essential that the board surface be smooth and flat. If the base material is damaged see appropriate procedure.

NOTE

This method uses commercially available replacement surface mount pads. The new pads are fabricated from copper foil. They are available in hundreds of sizes and shapes and are generally supplied solder plated. If a special size or shape is needed they can be custom fabricated.

REFERENCES

- 1.0 Foreword
- 2.1 Handling Electronic Assemblies
- 2.2 Cleaning
- 2.5 Baking And Preheating
- 2.7 Epoxy Mixing and Handling

TOOLS & MATERIALS

- Buffer
- Circuit Frames, Pads
- Cleaner
- Epoxy
- Flux, Liquid
- Heat Lamp
- Microscope
- Oven
- Precision Knife
- Scraper
- Solder
- Soldering Iron
- Tape, High Temperature
- Tweezers
- Wipes

PROCEDURE

1. Clean the area.
2. Remove the defective pad and a short length of the connecting circuit. (See Figure 1).
3. Use knife and scrape off any epoxy residue, contamination or burned material from the board surface.

CAUTION

Abrasion operations can generate electrostatic charges.

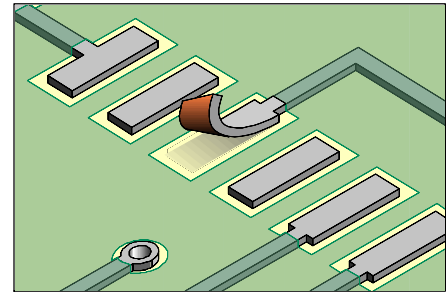

Damaged Surface Mount Pad

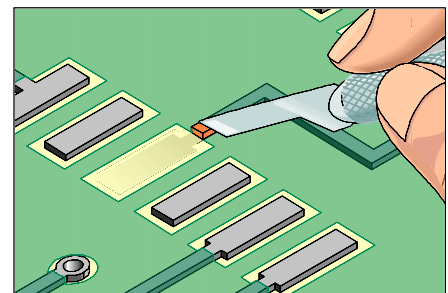

Figure 1: Remove the defective pad and remove soldermask from the connecting circuit.

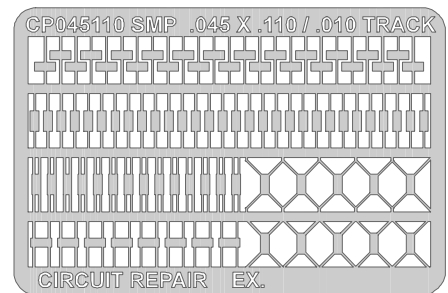

Figure 2: Select a commercially available replacement pad that matches the missing pad.

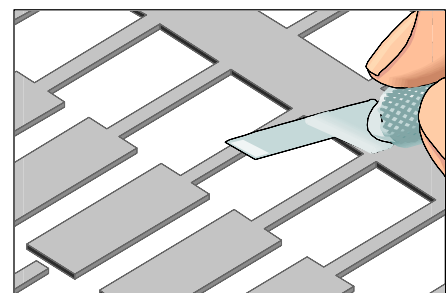

Figure 3: Cut out the new surface mount pad.

4. Scrape off any solder mask or coating from the connecting circuit. (See Figure 1).
5. Clean the area.
6. Apply a small amount of liquid flux to the connection area on the board surface and tin with solder. Clean the area. The length of the overlap solder connection should be a minimum of 2 times the circuit width.
7. The area for the new pad on the board surface must be smooth and flat. If internal fibers of the board are exposed or if there are deep scratches in the surface they should be repaired. Refer to appropriate procedure.
8. Select a commercially available surface mount pad that most closely matches the surface mount pad to be replaced. If a special size or shape is needed they can be custom fabricated. (See Figure 2).
9. Cut out and trim the new pad. Cut the length to provide the maximum allowable circuit overlap for soldering. Minimum 2 times the circuit width. (See Figure 3).

NOTE

The new replacement surface mount pad may be trimmed from copper sheet.

10. Mix the epoxy and apply a small amount to the surface where the new pad will be placed.
11. Place a piece of High Temperature Tape over the top surface of the new pad. Place the new pad into position on the PC board surface using the tape to help in alignment. (See Figure 4).
12. Cure the epoxy per Procedure 2.7 Epoxy Mixing and Handling.

CAUTION

Some components may be sensitive to high temperature.

13. After the epoxy has cured remove the High Temperature Tape used for alignment. Carefully clean the area and inspect the new pad for proper alignment.
14. If the new pad has a connecting circuit apply a small amount of liquid flux to the lap solder joint connection area and solder the circuit from the new pad to the circuit on the PC board surface. Use minimal flux and solder to ensure a reliable connection. High Temperature Tape may be placed over the top of the new pad to prevent excess solder overflow.

NOTE

If the configuration permits, the overlap solder joint connection should be a minimum of 3.00 mm (0.125") from the related

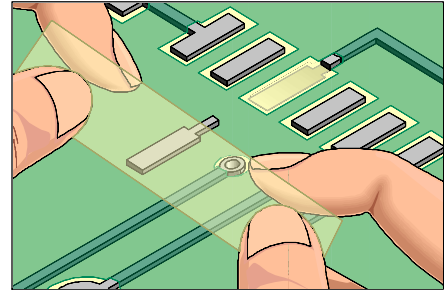

Figure 4: Place the new surface mount pad in place using High Temperature Tape.

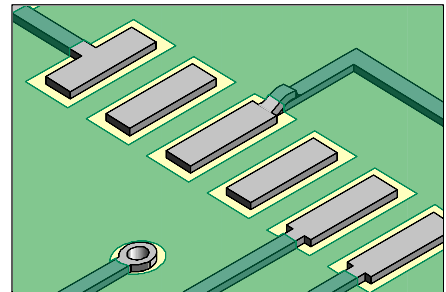

Figure 6: Completed repair.

termination. This gap will minimize the possibility of simultaneous reflow during soldering operations. Refer to 7.1 Soldering Basics.

15. Mix epoxy and coat the lap solder joint connections. Cure the epoxy per the manufacturers recommended instructions.

NOTE

Additional epoxy can be applied around the perimeter of the new pad to provide additional bond strength.

16. Apply surface coating to match prior coating as required.

EVALUATION

1. Visual examination
2. Measurement of new pad width and spacing.
3. Electrical continuity measurement.

OUTLINE

This method is used to replace damaged surface mount pads with new dry film, adhesive backed pads. The new pads are bonded to the PC board surface using a specially designed bonding press or bonding iron.

CAUTION

It is essential that the board surface be smooth and flat. If the base material is damaged see appropriate procedure.

NOTE

This method uses replacement surface mount pads. The new pads are fabricated from copper foil. They are available in hundreds of sizes and shapes and are generally supplied solder plated. If a special size or shape is needed they can be custom fabricated.

REFERENCES

- 1.0 Foreword
- 2.1 Handling Electronic Assemblies
- 2.2 Cleaning
- 2.5 Baking and Preheating
- 2.7 Epoxy Mixing and Handling

TOOLS & MATERIALS

Bonding Iron
Bonding Tips
Bonding System
Circuit Frames, Surface Mount Pads
Cleaner
Epoxy
Flux, Liquid
Heat Lamp
Microscope
Oven
Precision Knife
Repair System or Repair Kit
Scraper
Solder
Soldering Iron
Tape, High Temperature
Tweezers
Wipes

PROCEDURE

1. Clean the area.
2. Remove the defective pad and a short length of the connecting circuit. (See Figure 1).

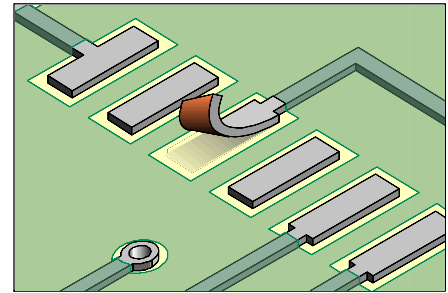

Damaged Surface Mount Pad

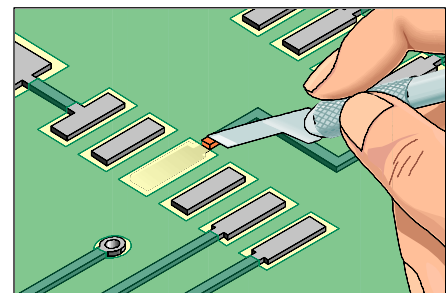

Figure 1: Remove the defective pad and remove soldermask from the connecting circuit.

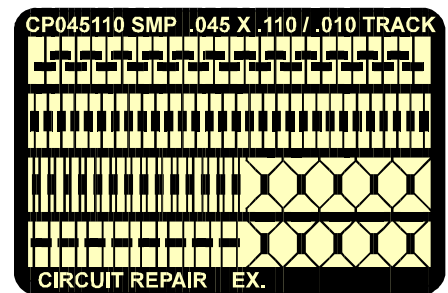

Figure 2: Select a replacement pad that matches the missing pad.

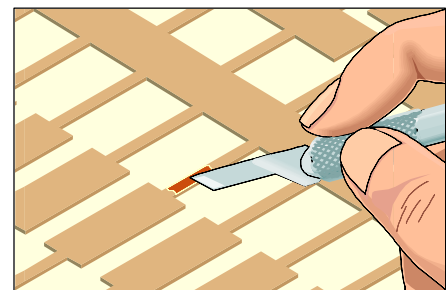

Figure 3: Scrape off the adhesive bonding film from the solder joint area on the back of new pad.

3. Use a knife and scrape off any epoxy residue, contamination or burned material from the board surface.
4. Scrape off any solder mask or coating from the connecting circuit. (See Figure 1).
5. Clean the area.
6. Apply a small amount of liquid flux to the connection area on the board surface and tin with solder. Clean the area. The length of the overlap solder connection should be a minimum of 2 times the circuit width.
7. The area for the new pad on the board surface must be smooth and flat. If internal fibers of the board are exposed, or if there are deep scratches in the surface, they should be repaired. Refer to appropriate procedure.
8. Select a replacement surface mount pad that most closely matches the surface mount pad to be replaced. If a special size or shape is needed they can be custom fabricated. (See Figure 2).

NOTE

New surface mount pads are fabricated from copper foil. The foil is plated on the top side with solder, and an adhesive bonding film is applied to the bottom side.

9. Before trimming out the new pad carefully scrape off the adhesive bonding film from the solder joint connection area on the back of the new pad. (See Figure 3).

CAUTION

Scrape off the epoxy backing only from the joint connection area. When handling the replacement contact, avoid touching the epoxy backing with your fingers or other materials that may contaminate the surface and reduce the bond strength.

10. Cut out and trim the new pad. Cut out from the plated side. Cut the length to provide the maximum allowable circuit overlap for soldering. Minimum 2 times the circuit width. (See Figure 4).
11. Place a piece of High Temperature Tape over the top surface of the new pad. Place the new pad into position on the PC board surface using the tape to help in alignment. Leave the tape in place during the bonding cycle. (See Figure 5).
12. Select a bonding tip with a shape to match the shape of the new pad. See bonding tip chart in the replacement parts section of the manual provided with the repair system or repair kit.

NOTE

The tip used for bonding should be as small as possible but should completely cover the entire surface of the new pad.

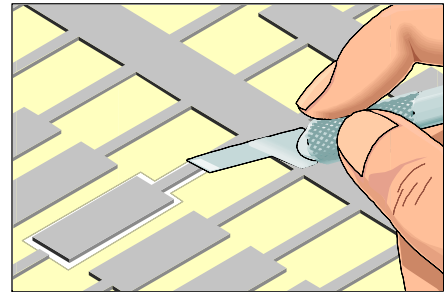

Figure 4: Cut out the new surface mount pad. Cut from the plated side.

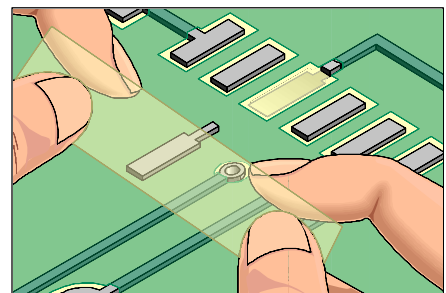

Figure 5: Place the new surface mount pad in place using High Temperature Tape.



Figure 6: Bond the new pad using a Bonding System.

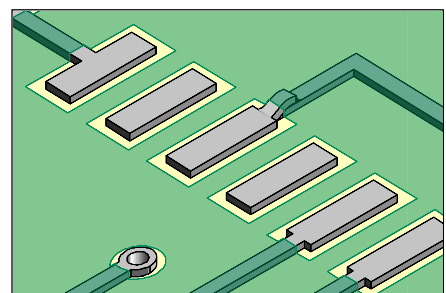

Figure 7: Completed repair.

13. Position the PC board so that it is flat and stable. Gently place the hot bonding tip onto the tape covering the new pad. Apply pressure as recommended in the manual of the repair system or repair kit. (See Figure 6).

CAUTION

Excessive bonding pressure may cause measling in the PC board surface or may cause the new pad to slide out of position.

14. After the timed bonding cycle lift the bonding iron and remove the tape used for alignment. The pad is fully cured. Carefully clean the area and inspect the new pad for proper alignment.
15. If the new pad has a connecting circuit apply a small amount of liquid flux to the lap solder joint connection area and solder the circuit from the new pad to the circuit on the PC board surface. Use minimal flux and solder to ensure a reliable connection. Tape may be placed over the top of the new pad to prevent excess solder overflow.

NOTE

If the configuration permits, the overlap solder joint connection should be a minimum of 3.00 mm (0.125") from the related termination. This gap will minimize the possibility of simultaneous reflow during soldering operations. Refer to 7.1 Soldering Basics.

16. Mix epoxy and coat the lap solder joint connection. Cure the epoxy per Procedure 2.7 Epoxy Mixing and Handling.

NOTE

Additional epoxy can be applied around the perimeter of the new pad to provide additional bond strength.

CAUTION

Some components may be sensitive to high temperature.

17. Apply surface coating to match prior coating as required.

EVALUATION

1. Visual examination
2. Measurement of new pad width and spacing.
3. Electrical continuity measurement.

OUTLINE

This procedure covers the repair of a damaged hole that has no inner layer connection. An eyelet is used to repair the damage to the hole and the eyelet flanges replace the pads on the PC board surface.

CAUTION

This procedure is used only to restore the integrity of a through connection in a double sided board or a multilayer board where there is no inner layer connection. If there is an inner layer connection see appropriate procedure.

REFERENCES

- 1.0 Foreword
- 2.1 Handling Electronic Assemblies
- 2.2 Cleaning

TOOLS & MATERIALS

- Ball Mill
- Caliper Gauges
- Cleaner
- Eyelet Press System
- Eyelet Kit
- Eyelets , Funnel Flange, Various Sizes
- Eyelets , Flat Flange, Various Sizes
- Flux, Liquid
- Micro-Drill System
- Microscope
- Pin Gauges
- Precision Knife
- Setting Form Tool, Various Sizes
- Setting Anvil, Various Sizes
- Solder Iron
- Solder
- Wipes

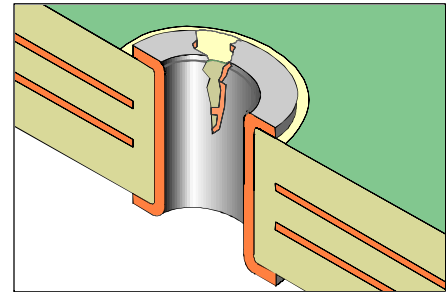

Damaged Plated Hole



Figure 1: Drill out the hole using a Micro-Drill System and ball mill.

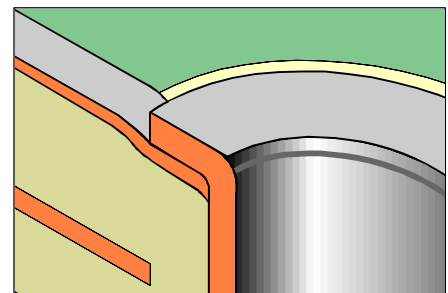

Figure 2: The eyelet flange can be used to secure a new circuit in place.



Figure 3: Set the eyelet using an Eyelet Press System.

EYELET SELECTION CRITERIA

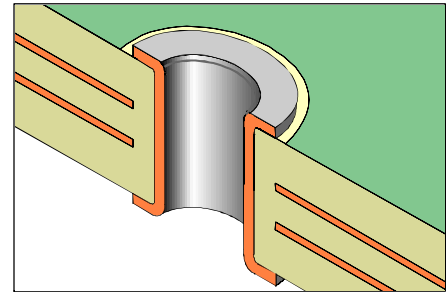
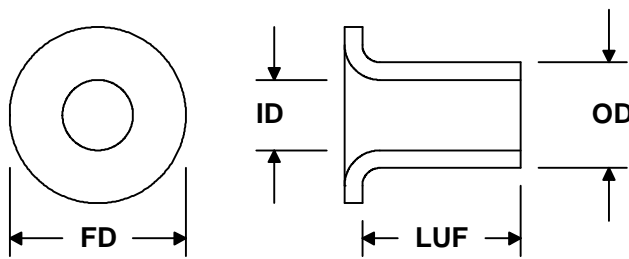

Figure 4: Completed repair.

ID Inside Diameter

The eyelet inside diameter should be a .075 - .500 mm (.003"-.020") greater than the component lead diameter.

LUF Length Under Flange

The length of the eyelet barrel under the flange should be .630 - .890 mm (.025" - .035") greater than the thickness of the PC board. This added length allows for proper protrusion when setting the eyelet.

FD Flange Diameter

The eyelet flange diameter should be small enough to prevent interference with adjacent pads or circuits.

OD Outside Diameter

The clearance hole should allow the eyelet to be inserted without force but should not exceed .125 mm (.005") greater than the eyelet outside diameter.

NOTE

Be sure to select an eyelet meeting the proper criteria. An eyelet with an oversize flange may interfere with adjacent circuits. An eyelet that is too short will not protrude through the PC board for proper setting.

PROCEDURE

1. Clean the area.
2. Select an eyelet using the Eyelet Selection Criteria. Use a pin gauge and caliper to measure the existing plated hole dimensions.
3. Insert the appropriate ball mill into the Micro-Drill System. Drill out the hole removing all the plating. The drilled hole should be .025 - .125 mm (.001" - .005") larger than the eyelet O.D. (See Figure 1).

CAUTION

This procedure may isolate internal connections on multilayer PC boards.

4. Clean the area.

5. Apply a small amount of liquid flux to the pad or circuit on the PC board surface, if any, and tin with solder using a soldering iron and solder. Clean the area.
6. Insert the eyelet into the hole. If a new circuit is required, the new circuit may extend into the drilled hole and the flange of the eyelet will secure the new circuit in place. (See Figure 2).
7. Select the proper setting tools and insert them into an eyelet press system. (See Figure 3).
8. Turn the PC board over and rest the eyelet flange on the lower setting tool.
9. Apply firm even pressure to form the eyelet barrel.

NOTE

Inspect the eyelet flange for evidence of damage. Refer to IPC-A-610 Acceptability of Electronic Assemblies.

10. Apply a small amount of liquid flux and solder the eyelet flanges to the pads on the PC board surface if necessary. Clean the area. Inspect for good solder flow and wetting around the eyelet flanges and lands.

EVALUATION

1. Visual examination, dimensional requirement of pad diameter and inside diameter.
2. Electrical continuity measurement.

OUTLINE

This procedure covers the use of an eyelet for the repair of a damaged pad on a hole that has an inner layer connect.

CAUTION

This method is used to restore the integrity of a through connection on a multilayer PC board, having an inner layer connect, but ONLY if the full barrel of the plated through hole remains intact. If there is barrel damage see appropriate procedure.

CAUTION

This method will reduce the inside diameter of the hole. The minimum hole size requirement must be checked for acceptance.

REFERENCES

- 1.0 Foreword
- 2.1 Handling Electronic Assemblies
- 2.2 Cleaning

TOOLS & MATERIALS

- Ball Mills
- Buffer
- Caliper
- Eyelet Press System
- Eyelet Kit
- Eyelets, Funnel Flange, Various Sizes
- Eyelets, Flat Flange, Various Sizes
- Flux, Liquid
- Micro-Drill System
- Microscope
- Pin Gauges
- Precision Knife
- Solder Iron
- Solder
- Wipes

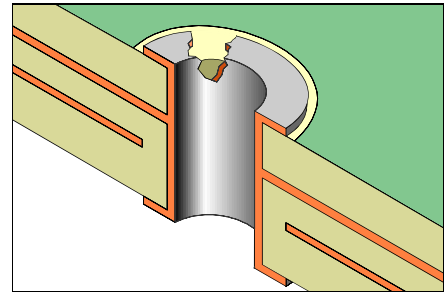

Damaged Plated Hole with Inner Layer Connection

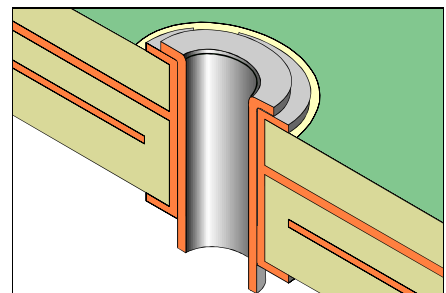

Figure 1: Insert the eyelet into the hole.



Figure 2: Set the eyelet using an Eyelet Press System.

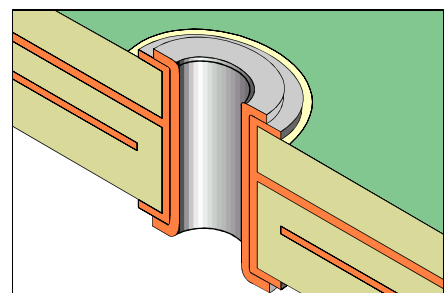
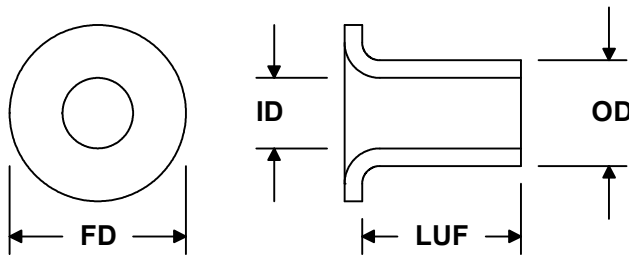

Figure 3: Completed repair.

EYELET SELECTION CRITERIA



ID Inside Diameter

The eyelet inside diameter should be a .075 - .500 mm (.003"-.020") greater than the component lead diameter.

LUF Length Under Flange

The length of the eyelet barrel under the flange should be .630 - .890 mm (.025" - .035") greater than the thickness of the PC board. This added length allows for proper protrusion when setting the eyelet.

FD Flange Diameter

The eyelet flange diameter should be small enough to prevent interference with adjacent pads or circuits.

OD Outside Diameter

The clearance hole should allow the eyelet to be inserted without force but should not exceed .125 mm (.005") greater than the eyelet outside diameter.

NOTE

Be sure to select an eyelet meeting the proper criteria. An eyelet with an oversize flange may interfere with adjacent circuits. An eyelet that is too short will not protrude through the PC board for proper setting.

PROCEDURE

1. Clean the area.
2. Examine the hole to ensure that there is no damage to the wall of the hole. Check continuity to establish the integrity of the connection.
3. Select an eyelet using the Eyelet Selection Criteria. Use a pin gauge and caliper to measure the existing plated hole dimensions. The eyelet must have an inside diameter sufficient to receive the component lead and an outside diameter that will allow the eyelet to be inserted into the hole without force.
4. Remove oxides from the surface pads where the eyelet is to be installed using a buffer and clean.

5. Apply a small amount of liquid flux to the pad or circuit on the PC board surface, if any, and tin with solder using a soldering Iron and solder. Clean the area.
6. Insert the eyelet into the hole. If a new circuit is required, the new circuit may extend into the hole and the flange of the eyelet will secure the new circuit in place. (See Figure 1).
7. Select the proper setting tools and insert them into the eyelet press. (See Figure 2).
8. Turn the PC board over and rest the eyelet flange on the lower setting tool.
9. Apply firm even pressure to form the eyelet barrel.
10. Apply a small amount of liquid flux and solder the eyelet flanges to the pads on the PC board surface if necessary. Clean the area. Inspect for good solder flow and wetting around the eyelet flanges and lands.
11. Clean the area.
12. Install the component lead and solder, if required.

EVALUATION

1. Visual examination, dimensional requirement of pad diameter and inside diameter.
2. Electrical continuity measurement.

OUTLINE

This procedure describes the use of flat set eyelets for the repair of a through connection that has an inner layer connect, no surface wire is used. The inner layer reconnect is established by soldering the barrel of an eyelet to the exposed inner layer and the connection is encapsulated in high strength epoxy.

CAUTION

This is a complex repair procedure that demands the proper tools and materials. To expect reliable results, repair technicians must have a high level of expertise. Use this method only when alternative methods are unacceptable.

CAUTION

This procedure requires very accurate control over the location and depth of a milled hole. It is recommended that a precision drill system be used in combination with a high power stereo microscope.

REFERENCES

- 1.0 Foreword
- 2.1 Handling Electronic Assemblies
- 2.2 Cleaning

TOOLS & MATERIALS

- Ball Mills
- Buffer
- Caliper
- Cleaner
- End Mills
- Eyelet Kit
- Eyelet Press System
- Eyelets, Flat Flange, Various Sizes
- Eyelets, Funnel Flange, Various Sizes
- Flux, Liquid
- Micro-Drill System
- Microscope
- Pin Gauges
- Precision Drill System
- Precision Knife
- Solder Iron
- Solder
- Wipes

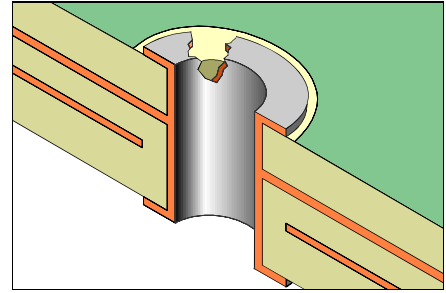

Damaged Plated Hole with Inner Layer Connection



Figure 1: Precision Drill System shown with PC board pinned in place.

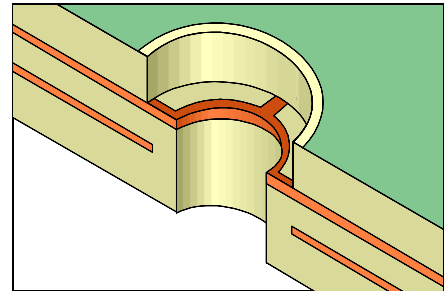

Figure 2: Mill down to and expose inner layer signal or plane.

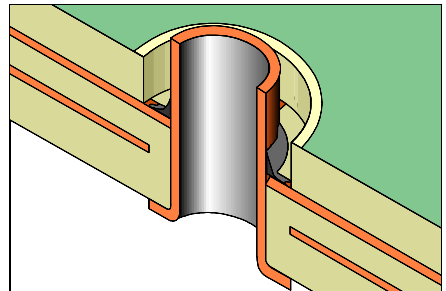
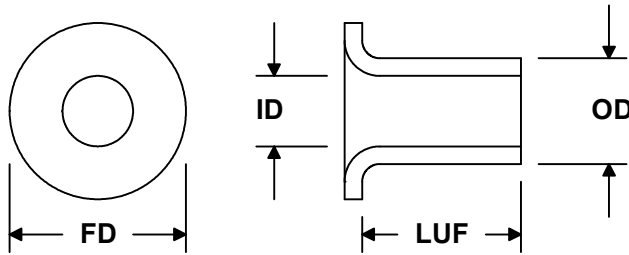

Figure 3: Solder the eyelet barrel to the exposed inner layer signal or plane.

EYELET SELECTION CRITERIA



- ID Inside Diameter**
The eyelet inside diameter should be a .075 - .500 mm (.003"-.020") greater than the component lead diameter.
- LUF Length Under Flange**
The length of the eyelet barrel under the flange should be .630 - .890 mm (.025" - .035") greater than the thickness of the PC board. This added length allows for proper protrusion when setting the eyelet.
- FD Flange Diameter**
The eyelet flange diameter should be small enough to prevent interference with adjacent pads or circuits.
- OD Outside Diameter**
The clearance hole drilled through the PC board should allow the eyelet to be inserted without force but should not exceed .125 mm (.005") greater than the eyelet outside diameter.

NOTE
Be sure to select an eyelet meeting the proper criteria. An eyelet with an oversize flange may interfere with adjacent circuits. An eyelet that is too short will not protrude through the PC board for proper setting.

PROCEDURE

1. Clean the area.
2. Select an eyelet using the Eyelet Selection Criteria. Use a pin gauge and caliper to measure the existing plated hole dimensions.
3. Pin the PC board to the base of the Precision Drill System. (See Figure 1).
4. Insert the appropriate ball mill, end mill or drill into the chuck of the drill press.
5. Mill or drill out the hole. The drilled hole should be approximately .030 mm (0.001") larger than the eyelet O.D. Inspect to ensure no metallic particles or burrs remain.

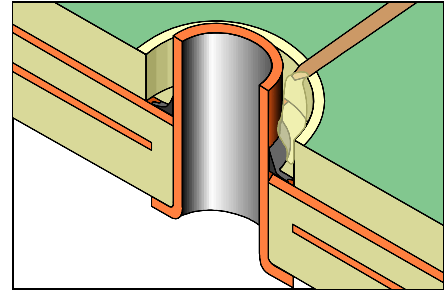

Figure 4: Fill the milled hole with the epoxy up to, and level with, the surface of the board.



Figure 5: Set the eyelet using an Eyelet Press System.

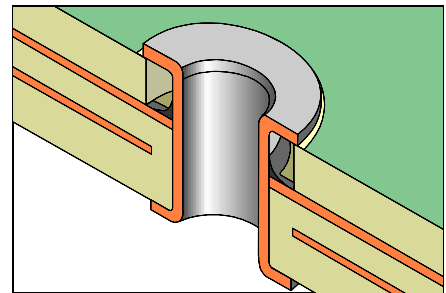

Figure 6: Eyelet barrel formed flat to PCB surface.

6. Select the side of the assembly that will have a counterbored hole milled into it. This side preferably would have no surface connection.
7. Select an end mill approximately .050 - .075 mm (.020" - .030") larger than the eyelet diameter. Insert into the Precision Drill System and mill down to and expose the inner layer signal or plane. (See Fig. 2).

CAUTION

Great care must be taken to control the depth of the milled hole to prevent damage to the inner layer signal or plane.

8. Clean the area.
9. Apply a small amount of flux to the exposed signal or plane and tin with solder.
10. Clean the area.
11. Insert the eyelet into the hole from the side opposite the milled hole, then apply a small amount of flux into the milled hole.
12. Solder the eyelet to the exposed inner layer signal or plane by applying heat from a soldering iron to the barrel of the eyelet. (See Figure 3).
13. Completely remove any solder flux residue by spray rinsing with cleaner.
14. Use a microscope and inspect the solder fillet from the eyelet to the inner connection and perform electrical tests as required.
15. Mix epoxy as required.
16. Fill the milled hole with the epoxy up to, and level with, the surface of the board. (See Figure 4). The epoxy filler material should be free of voids and air bubbles.
17. Cure the epoxy per Procedure 2.7 Epoxy Mixing and Handling.
18. Select the proper setting tools and insert them into the eyelet press. (See Figure 5).
19. Turn the PC board over and rest the eyelet flange on the lower setting tool.
20. Apply firm even pressure to form the eyelet barrel. (See Figure 6).
21. Install the component lead and solder, if required.
22. Clean the area.

EVALUATION

1. Visual examination, dimensional requirement of pad diameter and inside diameter.
2. Electrical continuity as required.

OUTLINE

This procedure covers the use of jumper wires to complete electrical continuity between two points on a PC board assembly. This procedure is meant to present a foundation for adding jumper wires and the techniques and guidelines come from general commercial and industry practices.

This procedure has 9 main sections.

1. References
2. Tools and Materials
3. General Rules
4. PC Board Preparation
5. Jumper Wire Selection
6. Jumper Wire Preparation
7. Jumper Wire Termination
8. Jumper Wire Routing
9. Jumper Wire Bonding

REFERENCES

- 1.0 Foreword
- 2.1 Handling Electronic Assemblies
- 2.2 Cleaning
- 2.5 Baking and Preheating
- 6.2 Jumper Wires, Through Hole Components
- 6.3 Jumper Wires, Chip Components, Pads and Conductors
- 6.4 Jumper Wires, J Lead Components
- 6.5 Jumper Wires, Gull Wing Components
- 7.1 Soldering Basics

TOOLS & MATERIALS

Adhesive, Hot Melt
Adhesive, Quick Set
Cleaner
Cleaning Wipes
Flush Cutter
Flux, Liquid
Smooth Pliers
Solder
Soldering Iron with Tips
Tape Dots
Wire Stripper
Wire

GENERAL RULES

1. Jumper wires are considered components and should be covered by an engineering instruction document for routing, termination, bonding and wire type. The ECO originator is responsible for defining any special routing of wires.

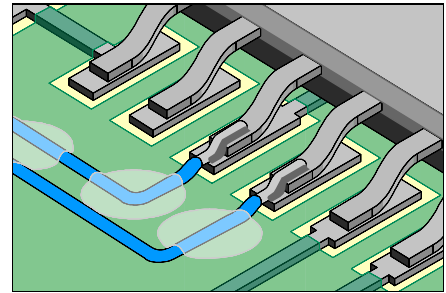

Jumper Wires

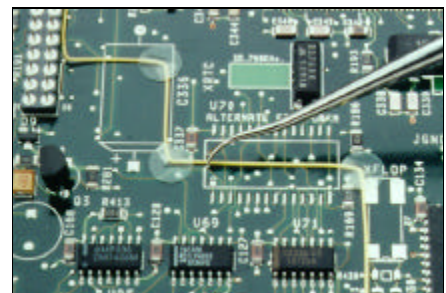

Figure 1: Wires may be held in place with Tape Dots for a quick neat job.

2. Jumper wires shall be placed on the component side of the PC board unless no other alternative is available.
3. Jumper wires shall be routed as directly as feasible, making as few bends as possible.
4. Jumper wires shall not be raised more than 3.0 mm (.125") inch above the board surface or not above components or leads in such a way that they will interfere with PC board mounting.
5. The jumper wire shall not violate minimum space requirements.
6. Jumper wires may pass over solder lands provided sufficient slack is available so that the wire can be moved away from the solder land for component replacement. Jumpers wires shall not pass over pads or vias used as test points unless no alternative is available.
7. Jumper wires shall not be routed under or over component leads or component bodies unless no alternative is available. Contact with heat sinks must be avoided.
8. Except for connections at the edge of the board, jumper wires shall not pass through component foot prints unless the layout of the assembly prohibits the routing in other areas.
9. There shall be no tension in the jumper wire.
10. Jumper wires shall not be routed through a standard plated through hole from one side of the board to another. Where it is necessary to have a connection from one side of the board to the other more than one wire may be used if practical. If a hole is needed use the following method.
 - A. Drill a hole .25 mm (.010") larger than the insulation diameter.
 - B. Inspect the hole for burs or exposed internal circuits.
 - C. Document the added hole on a control drawing.

NOTE

Be careful that the drilled hole does not interfere with surface and internal conductors.

11. Jumper wires may be terminated by a variety of methods. (See Table 3 - Jumper Wire Termination Methods).
12. Jumper wires less than 13.0 mm (0.50") long and whose path does not pass over conductive areas may be un-insulated.

PC BOARD PREPARATION

1. Clean the area.

NOTE

When wires are in place cleaning will often be more difficult.

2. Remove coating material or oxidization from the component leads, pads, or conductors where wire terminations will be soldered. Clean the area.
3. Remove solder from the connection point if needed. Clean the area.
4. Measure approximately the length of each wire needed.

JUMPER WIRE SELECTION

1. Jumper wires should be insulated if greater than 13.0 mm (0.50") long or is liable to short between lands or component leads.
2. Silver plated wire should not be used as under some conditions corrosion of the wire can occur.
3. The smallest diameter wire that will carry the required current should be selected.
4. Insulation requirements of the wire should withstand soldering temperatures, have some resistance to abrasion, have a dielectric resistance equal to or better than the board insulation material.
5. Recommended wire is solid insulated copper wire, tin lead plated, 22 to 32 AWG with Kynar, Milene, Kapton, Teflon or equivalent insulation.

CAUTION

Wires with nicked or damaged conductors should not be used.

JUMPER WIRE PREPARATION

1. Cut the jumper wires approximately 13.0 mm (0.50") longer than the estimated length needed.

NOTE

The length and gauge of the jumper wire may be critical. All wires have an electrical resistance (impedance) to the flow of electricity. This impedance is important to electronic circuitry. Always refer to wiring lists for specific jumper wire requirements.

2. Strip insulation from each end of the jumper wire. See Table 1 for recommended Jumper Wire Strip Length. See Acceptability Criteria section on stripping for proper stripping information and diagrams.

Table 1 - Jumper Wire Strip Lengths

Type of Jumper Wire Termination	Strip Length
Wire lap soldered to component leads or surface circuits.	6.0 mm (0.25")
Wire soldered into plated through holes.	13.0 mm (0.50")
Wire wrapped and soldered to pins, terminals or component leads.	13.0 mm (0.50")

NOTE

The strip length may be adjusted depending on the termination. Stripping insulating material from jumper wires should always be done with a qualified strip tool.

- If required, add liquid flux to the stripped ends and tin with solder. Clean the wire ends.

JUMPER WIRE TERMINATIONS

Lap Soldered to Component Leads or Surface Conductors

- Form the wire as needed and place the wire in position depending on the termination type. Center the wire on the component lead or pad, do not overhang sides.

NOTE

Make sure the solder joint length and insulation gap spacing will meet the acceptability requirements.

- Bend the wire as needed and run the wire along PC board surface.

NOTE

Wires may run over component body only when approved. More than 1 wire may be soldered at each termination, but wires shall not overhang the edges.

- Apply flux and solder one end of the wire. After terminating the wire, clean the area.

CAUTION

The insulation shall not be stripped back more than 2 wire diameters from the solder joint. Wire insulation may touch but not penetrate the solder joint.

- After routing the jumper wire, solder the opposite end.

CAUTION

Wires soldered to lifted or clipped components leads may require insulation to prevent shorting.

Soldered into Plated Through Holes

1. Form the wire as needed and place the wire into the cleared plated through hole.

NOTE

Make sure the solder joint length and insulation gap spacing will meet the acceptability requirements.

2. Bend the wire as needed and run the wire along PC board surface.

NOTE

Wires may run over component body only when approved. More than one wire may be inserted into the hole, but the wires should not be forced.

3. Apply flux and solder one end of the wire. After terminating the wire, clean the area.

CAUTION

The insulation shall not be stripped back more than 2 wire diameters from the solder joint. Wire insulation may touch but not penetrate the solder joint.

4. After routing the jumper wire, solder the opposite end.

CAUTION

Wires soldered to lifted or clipped components leads may require insulation to prevent shorting.

Wrapped and Soldered to Pins, Terminals or Component Leads

1. Form the wire around the pin, terminal or component lead. For round terminals/pins, wrap the wire 270°. For flat terminals/pins, wrap the wire 180°.

NOTE

Make sure the solder joint length and insulation gap spacing will meet the acceptability requirements.

2. Bend the wire as needed and run the wire along PC board surface.

NOTE

Wires may run over component body only when approved. More than one wire may be wrapped around each terminal or pin, but the wires must not overlap each other.

3. Apply flux and solder one end of the wire. After terminating the wire, clean the area.

CAUTION

The insulation shall not be stripped back more than 2 wire diameters from the solder joint. Wire insulation may touch but not penetrate the solder joint.

4. After routing the jumper wire, solder the opposite end.

CAUTION

Wires soldered to lifted or clipped components leads may require insulation to prevent shorting.

JUMPER WIRE ROUTING

1. Route the jumper wire by the shortest route and with the fewest possible bends to the second termination point. Wires are normally routed in an X/Y Direction. Refer to Basic Rules for additional information about wire routing.

NOTE

Do not exceed the minimum bend radius in the wire.

Table 2 - Wire Bend Radius Specifications

Wire Type	Preferred Bend Radius	Minimum Bend Radius
Individual Solid Wire	4X Diameter	2X Diameter
Individual Stranded Wire	10X Diameter	3X Diameter
Unsleeved Harness Wire	10X Diameter	3X Diameter
Sleeved Harness Wire	10X Diameter	5X Diameter
Multi-conductor Cable	10X Diameter	5X Diameter
Single Conductor Shield or Coaxial Cable	10X Diameter	8X Diameter

JUMPER WIRE BONDING

After the wire has been soldered to both ends and routed, the wire should be bonded to the PC Board surface.

NOTE

Jumper wire should be bonded to the PC Board surface within 6.0 mm (0.25") of the solder joints, within 6.0 mm (0.25") of each bend and at intervals of not less than 25 mm (1.0") on straight wire runs.

Jumper wires should be bonded using one of the following methods.

- A. Tape Dots (See Figure 1)
- B. Hot Melt Glue
- C. Quick Set Adhesive.

OUTLINE

This procedure covers the specific application of jumper wires to through hole components. Refer to procedure 6.1 Jumper Wire Basics for detailed information about, Tools and Materials, General Rules, PC Board Preparation, Jumper Wire Selection, Jumper Wire Preparation, Jumper Wire Termination, Jumper Wire Routing and Jumper Wire Bonding.

REFERENCES

- 1.0 Foreword
- 2.1 Handling Electronic Assemblies
- 2.2 Cleaning
- 2.5 Baking and Preheating
- 6.1 Jumper Wire Basics
- 7.1 Soldering Basics

Jumper Wire Termination Methods - Through Hole Components

Type	Wire Termination Method	Acceptability	Fig.
PTH Lead	Wire soldered into plated through hole on component side.	Preferred	PLP1
PTH Lead	Wire soldered parallel to component lead on component side.	Preferred	PLP2
PTH Lead	Wire soldered into plated through hole on solder side.	Acceptable	PLA1
PTH Lead	Wire wrapped around component lead on solder side.	Acceptable	PLA2
PTH Lead	Wire wrapped around component lead on component side.	Acceptable	PLA3
PTH Lead	Wire soldered to lifted component lead.	Acceptable	PLA4
PTH Lead	Wire soldered to clipped component lead on component side.	Acceptable	PLA5
PTH Lead	Wire looped and soldered to adjacent component leads.	Acceptable	PLA6
PTH Lead	Wire soldered to component lead, wire running over component.	Not Recommended	PLN1
PTH Lead	Wire soldered perpendicular to component lead.	Not Recommended	PLN2
PTH Lead	Multiple wires soldered to component lead overhanging edge.	Not Recommended	PLN3

Jumper Wire Termination Figures - Through Hole Components

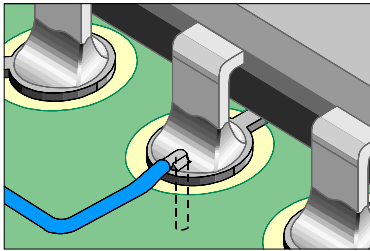

Figure PLP1
PTH Lead - Preferred
 Wire soldered into plated through hole on component side.

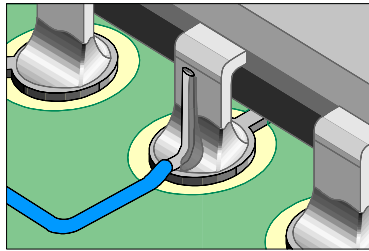

Figure PLP2
PTH Lead - Preferred
 Wire soldered parallel to component lead on component side.

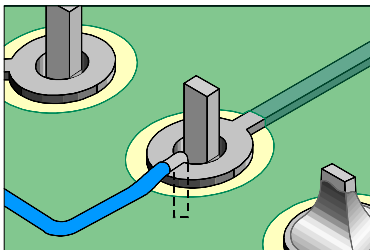

Figure PLA1
PTH Lead - Acceptable
 Wire soldered into plated through hole on solder side.

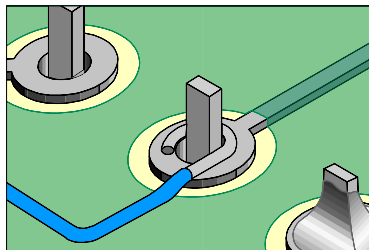

Figure PLA2
PTH Lead - Acceptable
 Wire wrapped around component lead on solder side.

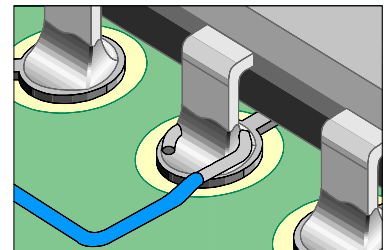

Figure PLA3
PTH Lead - Acceptable
 Wire wrapped around component lead on component side.

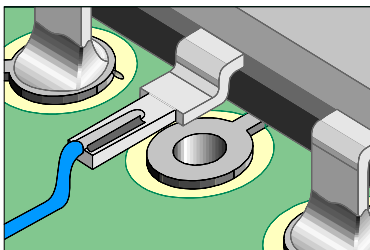

Figure PLA4
PTH Lead - Acceptable
 Wire soldered to lifted component lead.

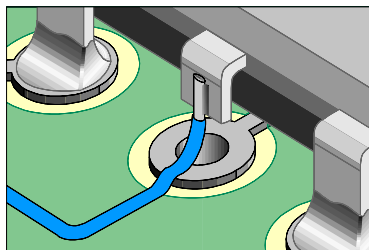

Figure PLA5
PTH Lead - Acceptable
 Wire soldered to clipped component lead on component side.

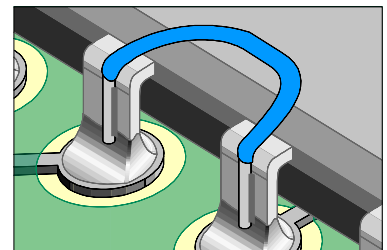

Figure PLA5
PTH Lead - Acceptable
 Wire looped and soldered to adjacent component leads.

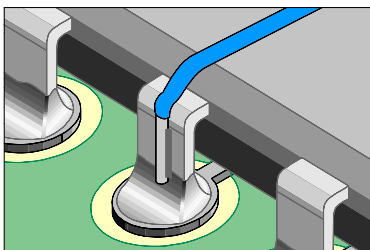

Figure PLN1
PTH Lead - Not Recommended
 Wire soldered to component lead, wire running over component.

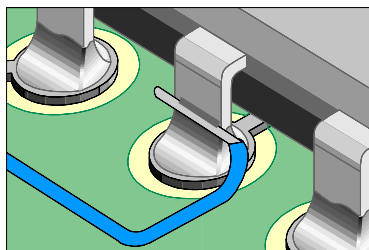

Figure PLN2
PTH Lead - Not Recommended
 Wire soldered perpendicular to component lead.

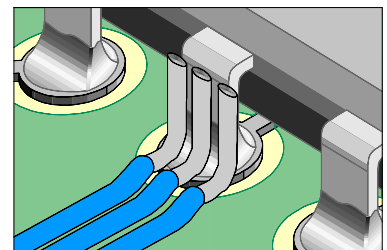

Figure PLN3
PTH - Not Recommended
 Multiple wires soldered to component lead overhanging edge.

OUTLINE

This procedure covers the specific application of jumper wires to chip components, pads and conductors. Refer to procedure 6.1 Jumper Wire Basics for detailed information about, Tools and Materials, General Rules, PC Board Preparation, Jumper Wire Selection, Jumper Wire Preparation, Jumper Wire Termination, Jumper Wire Routing and Jumper Wire Bonding.

REFERENCES

- 1.0 Foreword
- 2.1 Handling Electronic Assemblies
- 2.2 Cleaning
- 2.5 Baking and Preheating
- 6.1 Jumper Wire Basics
- 7.1 Soldering Basics

Jumper Wire Termination Methods - Chip Components, Pads and Conductors

Type	Wire Termination Method	Acceptability	Fig.
Chip	Wire soldered to pad, parallel or perpendicular to component.	Preferred	CHP1
Chip	Wire soldered parallel or perpendicular to component lead.	Acceptable	CHA1
Chip	Wire soldered to component end, lifted off pad.	Acceptable	CHA2
Chip	Multiple wires soldered to component end overhanging edge.	Not Recommended	CHN1
PTH Pad	Wire soldered into plated through hole.	Preferred	PPP1
PTH Pad	Wire soldered across top of PTH pad.	Acceptable	PPA1
PTH Pad	Multiple wires soldered to pad overhanging pad edge.	Not Recommended	PPN1
Conductor	Wire soldered parallel to conductor, contact, SMT pad.	Preferred	COP1
Conductor	Wire soldered perpendicular to conductor, contact, SMT pad.	Not Recommended	CON1
Conductor	Multiple wires soldered to conductor, contact, SMT pad.	Not Recommended	CON2

Jumper Wire Termination Figures - Chip Components

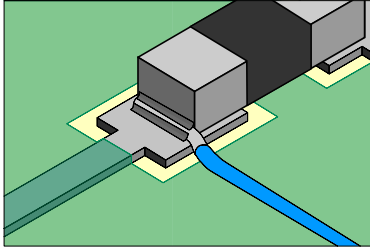

Figure CHP1
Chip Component - Preferred
Wire soldered to pad, parallel or perpendicular to component.

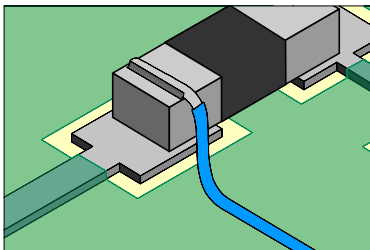

Figure CHA1
Chip Component - Acceptable
Wire soldered parallel or perpendicular to component lead.

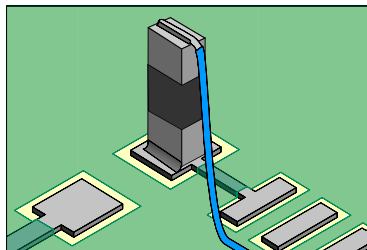

Figure CHA2
J Lead - Acceptable
Wire soldered to component end, lifted off pad.

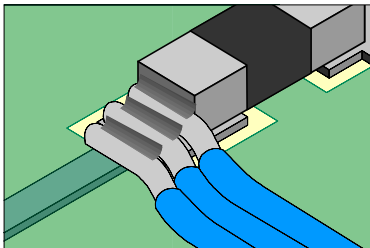

Figure CHN1
J Lead - Not Recommended
Multiple wires soldered to component end overhanging edge

Jumper Wire Termination Figures - Pads and Conductors

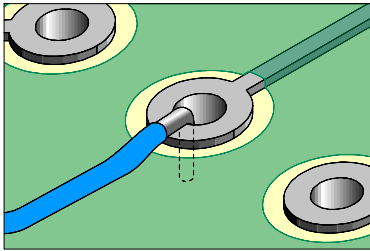

Figure PPP1
Plated Hole - Preferred
Wire soldered into plated through hole.

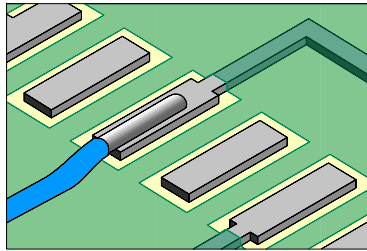

Figure COP1
Conductor - Preferred
Wire soldered parallel to conductor, contact, SMT pad.

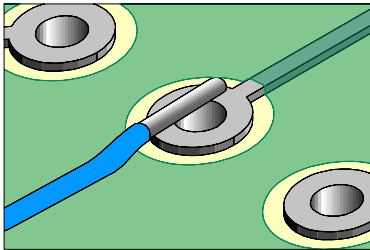

Figure PPA1
Plated Hole - Acceptable
Wire soldered across top of PTH pad.

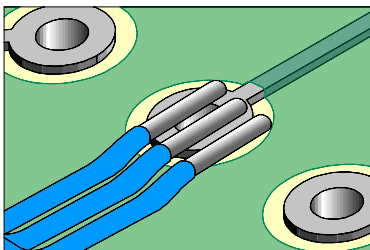

Figure PPN1
Plated Hole-Not Recommended
Multiple wires soldered to pad overhanging pad edge.

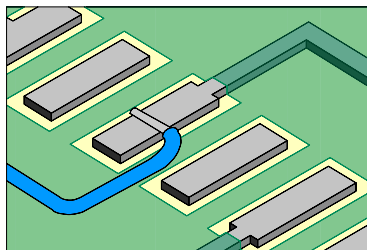

Figure CON1
Conductor - Not Recommended
Wire soldered perpendicular to conductor, contact, SMT pad.

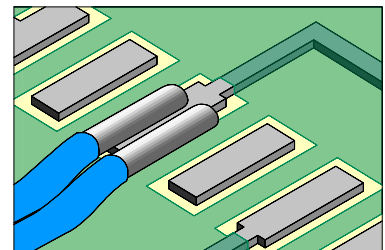

Figure CON2
Conductor- Not Recommended
Multiple wires soldered to conductor, contact, SMT pad.

OUTLINE

This procedure covers the specific application of jumper wires to J lead components. Refer to procedure 6.1 Jumper Wire Basics for detailed information about, Tools and Materials, General Rules, PC Board Preparation, Jumper Wire Selection, Jumper Wire Preparation, Jumper Wire Termination, Jumper Wire Routing and Jumper Wire Bonding.

REFERENCES

- 1.0 Foreword
- 2.1 Handling Electronic Assemblies
- 2.2 Cleaning
- 2.5 Baking and Preheating
- 6.1 Jumper Wire Basics
- 7.1 Soldering Basics

Jumper Wire Termination Methods - J Lead Components

Type	Wire Termination Method	Acceptability	Fig.
J Lead	Wire soldered parallel to component lead.	Preferred	JLP1
J Lead	Wire soldered to clipped component lead.	Acceptable	JLA1
J Lead	Wire looped and soldered to adjacent component leads.	Acceptable	JLA2
J Lead	Wire soldered to component lead, wire running over component.	Not Recommended	JLN1
J Lead	Wire soldered perpendicular to component lead.	Not Recommended	JLN2
J Lead	Multiple wires soldered to component lead overhanging edge.	Not Recommended	JLN3
J Lead	Wire soldered to lifted component lead.	Not Recommended	JLN4

Jumper Wire Termination Figures - J Lead Components

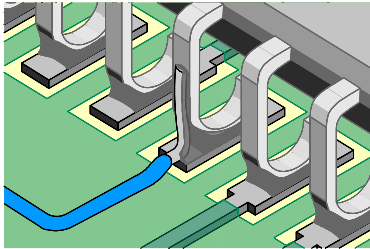

Figure JLP1
J Lead - Preferred
Wire soldered parallel to component lead.

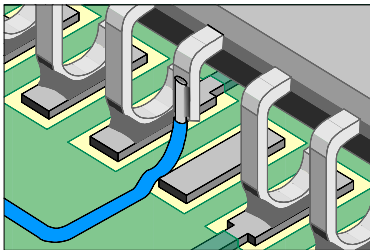

Figure JLA1
J Lead - Acceptable
Wire soldered to clipped component lead.

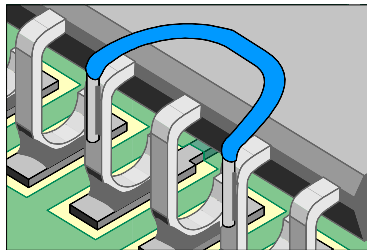

Figure JLA2
J Lead - Acceptable
Wire looped and soldered to adjacent component leads.

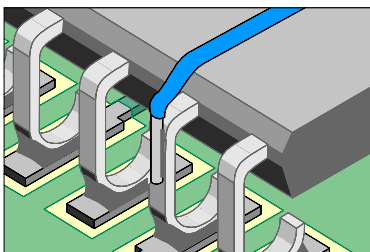

Figure JLN1
J Lead - Not Recommended
Wire soldered to component lead, wire running over component.

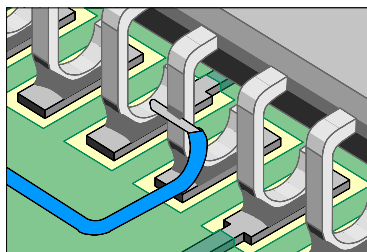

Figure JLN2
J Lead - Not Recommended
Wire soldered perpendicular to component lead.

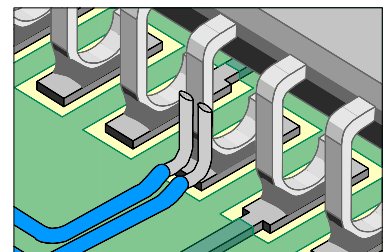

Figure JLN3
J Lead - Not Recommended
Multiple wires soldered to component lead overhanging edge.

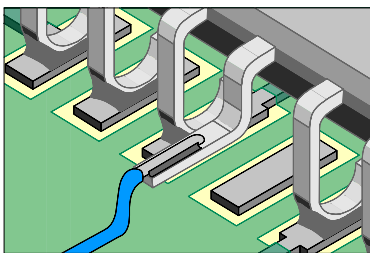

Figure JLN4
J Lead - Not Recommended
Wire soldered to lifted component lead.

OUTLINE

This procedure covers the specific application of jumper wires to gull wing components. Refer to procedure 6.1 Jumper Wire Basics for detailed information about, Tools and Materials, General Rules, PC Board Preparation, Jumper Wire Selection, Jumper Wire Preparation, Jumper Wire Termination, Jumper Wire Routing and Jumper Wire Bonding.

REFERENCES

- 1.0 Foreword
- 2.1 Handling Electronic Assemblies
- 2.2 Cleaning
- 2.5 Baking and Preheating
- 6.1 Jumper Wire Basics
- 7.1 Soldering Basics

Jumper Wire Termination Methods - Gull Wing Components

Type	Wire Termination Method	Acceptability	Fig.
Gull Wing	Wire soldered parallel to component lead.	Preferred	GWP1
Gull Wing	Wire soldered to lifted component lead.	Acceptable	GWA1
Gull Wing	Wire soldered to clipped component lead.	Acceptable	GWA2
Gull Wing	Wire looped and soldered to adjacent component leads.	Acceptable	GWA3
Gull Wing	Wire soldered to component lead, wire running over component.	Not Recommended	GWN1
Gull Wing	Wire soldered perpendicular to component lead.	Not Recommended	GWN2
Gull Wing	Multiple wires soldered to component lead overhanging edge.	Not Recommended	GWN3

Jumper Wire Termination Figures - Gull Wing Components

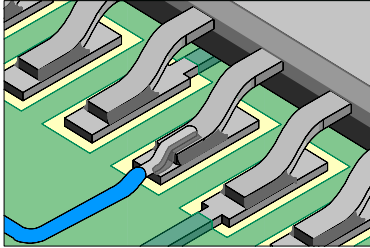

Figure GWP1
Gull Wing - Preferred
Wire soldered parallel to component lead.

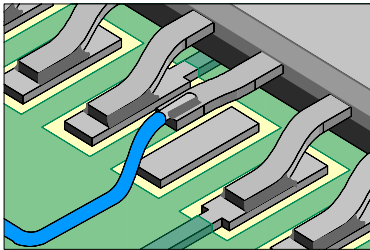

Figure GWA1
Gull Wing - Acceptable
Wire soldered to lifted component lead.

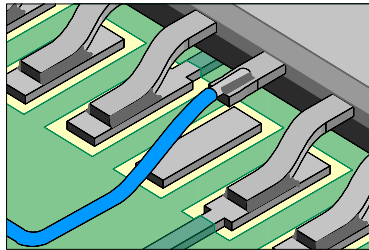

Figure GWA2
Gull Wing - Acceptable
Wire soldered to clipped component lead.

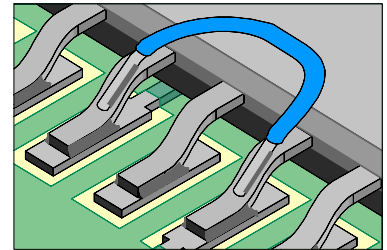

Figure GWA3
Gull Wing - Acceptable
Wire looped and soldered to adjacent component leads.

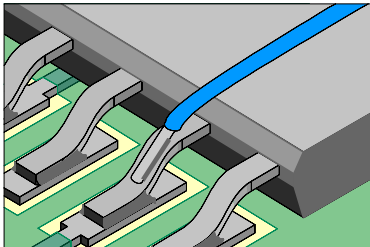

Figure GWN1
Gull Wing - Not Recommended
Wire soldered to component lead, wire running over component.

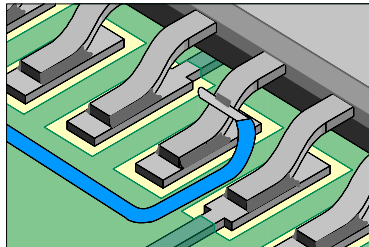

Figure GWN2
Gull Wing - Not Recommended
Wire soldered perpendicular to component lead.

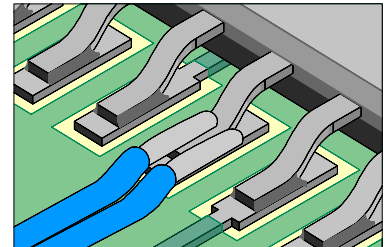

Figure GWN3
Gull Wing - Not Recommended
Multiple wires soldered to component lead overhanging edge.

OUTLINE

This procedure covers the basic concepts for high quality soldering.

REFERENCES

- 1.0 Foreword
- 2.1 Handling Electronic Assemblies
- 2.2 Cleaning
- 2.5 Baking and Preheating
- 7.1.2 Preparation For Soldering
- 8.1.1 Preparation For Component Removal

SOLDERING PROCESS

Soldering is the process of joining two metals by the use of a solder alloy, and it is one of the oldest known joining techniques. Faulty solder joints remain one of the major causes of equipment failure and thus the importance of high standards of workmanship in soldering cannot be overemphasized.

The following material covers basic soldering procedures and has been designed to provide the fundamental knowledge needed to complete the majority of high reliability hand soldering and component removal operations.

PROPERTIES OF SOLDER

Solder used for electronics is a metal alloy, made by combining tin and lead in different proportions. You can usually find these proportions marked on the various types of solder available.

With most tin/lead solder combinations, melting does not take place all at once. Fifty-fifty solder begins to melt at 183°C (361°F), but it's not fully melted until the temperature reaches 216°C (420°F). Between these two temperatures, the solder exists in a plastic or semi-liquid state.

The plastic range of a solder varies, depending upon the ratio of tin to lead. With 60/40 solder, the range is much smaller than it is for 50/50 solder. The 63/37 ratio, known as eutectic solder has practically no plastic range, and melts almost instantly at 183°C (361°F).

The solders most commonly used for hand soldering in electronics are the 60/40 type and the 63/37 type. Due to the plastic range of the 60/40 type, you need to be careful not to move any elements of the joint during the cool down period. Movement may cause what is known as disturbed joint. A disturbed joint has a rough, irregular appearance and looks dull instead of bright and shiny. A disturbed solder joint may be unreliable and may require rework.

WETTING ACTION

When the hot solder comes in contact with a copper surface, a metal solvent action takes place. The solder dissolves and penetrates the copper surface. The molecules of solder and copper blend to form a new alloy, one that's part copper and part solder. This solvent action is

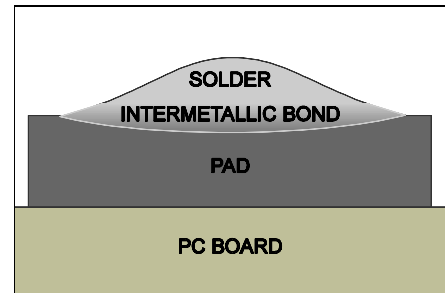

Figure 1: Wetting is when molten solder penetrates a copper surface, forming an intermetallic bond.

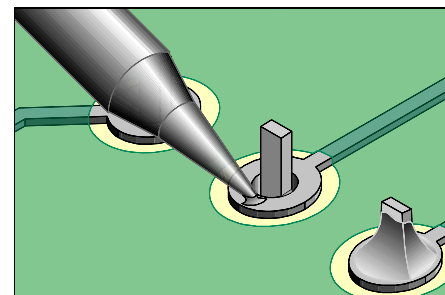

Figure 2: Minimal thermal linkage due to insufficient solder between the pad and soldering iron tip.

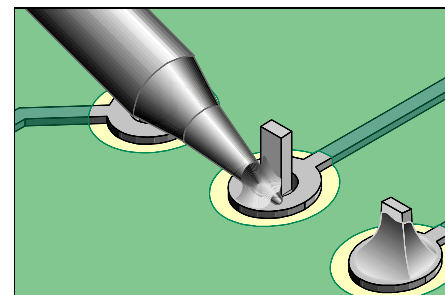

Figure 3: A solder bridge provides thermal linkage to transfer heat into the pad and component lead.

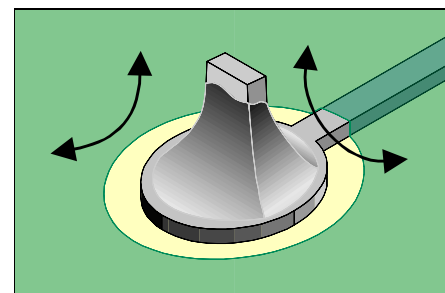

Figure 4: Solder blends to the soldered surface, forming a small contact angle.

called wetting and forms the intermetallic bond between the parts. (See Fig. 1). Wetting can only occur if the surface of the copper is free of contamination and from the oxide film that forms when the metal is exposed to air. Also, the solder and work surface need to have reached the proper temperature.

Although the surfaces to be soldered may look clean, there is always a thin film of oxide covering it. For a good solder bond, surface oxides must be removed during the soldering process using flux.

FLUX

Reliable solder connections can only be accomplished with truly cleaned surfaces. Solvents can be used to clean the surfaces prior to soldering but are insufficient due to the extremely rapid rate at which oxides form on the surface of heated metals. To overcome this oxide film, it becomes necessary in electronic soldering to use materials called fluxes. Fluxes consist of natural or synthetic rosins and sometimes chemical additives called activators.

It is the function of the flux to remove oxides and keep them removed during the soldering operation. This is accomplished by the flux action which is very corrosive at solder melt temperatures and accounts for flux's ability to rapidly remove metal oxides. In its unheated state, however, rosin flux is non-corrosive and non-conductive and thus will not affect the circuitry. It is the fluxing action of removing oxides and carrying them away, as well as preventing the reformation of new oxides that allows the solder to form the desired intermetallic bond.

Flux must melt at a temperature lower than solder so that it can do its job prior to the soldering action. It will volatilize very rapidly; thus it is mandatory that flux be melted to flow onto the work surface and not be simply volatilized by the hot iron tip to provide the full benefit of the fluxing action. There are varieties of fluxes available for many purposes and applications. The most common types include: Rosin - No Clean, Rosin - Mildly Activated and Water Soluble.

When used, liquid flux should be applied in a thin, even coat to those surfaces being joined and prior to the application of heat. Cored wire solder and solder paste should be placed in such a position that the flux can flow and cover the joints as the solder melts. Flux should be applied so that no damage will occur to the surrounding parts and materials.

SOLDERING IRONS

Soldering irons come in a variety of sizes and shapes. A continuously tinned surface must be maintained on the soldering iron tip's working surface to ensure proper heat transfer and to avoid transfer of impurities to the solder connection.

Before using the soldering iron the tip should be cleaned by wiping it on a wet sponge. When not in use the iron should be kept in a holder, with its tip clean and coated with a small amount of solder.

NOTE

Although tip temperature is not the key element in soldering you should always start at the lowest temperature possible. A good rule of thumb is to set the soldering iron tip temperature at 260°C (500°F) and increase the temperature as needed to obtain the desired result.

CONTROLLING HEAT

Controlling soldering iron tip temperature is not the key element in soldering. The key element is controlling the heat cycle of the work. How fast the work gets hot, how hot it gets, and how long it stays hot is the element to control for reliable solder connections.

THERMAL MASS

The first factor that needs to be considered when soldering is the relative thermal mass of the joint to be soldered. This mass may vary over a wide range.

Each joint, has its own particular thermal mass, and how this combined mass compares with the mass of the iron tip determines the time and temperature rise of the work.

SURFACE CONDITION

A second factor of importance when soldering is the surface condition. If there are any oxides or other contaminants covering the pads or leads, there will be a barrier to the flow of heat. Even though the iron tip is the right size and temperature, it may not be able to supply enough heat to the joint to melt the solder.

THERMAL LINKAGE

A third factor to consider is thermal linkage. This is the area of contact between the iron tip and the work.

Figure 2 shows a view of a soldering iron tip soldering a component lead. Heat is transferred through the small contact area between the soldering iron tip and pad. The thermal linkage area is small.

Figure 3 also shows a view of a soldering iron tip soldering a component lead. In this case, the contact area is greatly increased by having a small amount of solder at the point of contact. The tip is also in contact with both the pad and component further improving the thermal linkage. This solder bridge provides thermal linkage and assures the rapid transfer of heat into the work.

APPLYING SOLDER

In general, the soldering iron tip should be applied to the maximum mass point of the joint. This will permit the rapid thermal elevation of the parts to be soldered. Molten solder always flows from the cooler area toward the hotter one.

Before solder is applied; the surface temperature of the parts being soldered must be elevated above the solder melting point. Never melt the solder against the iron tip and allow it to flow onto a surface cooler than the solder melting temperature. Solder applied to a cleaned, fluxed and properly heated surface will melt and flow without direct contact with

the heat source and provide a smooth, even surface, filleting out to a thin edge. Improper soldering will exhibit a built-up, irregular appearance and poor filleting. For good solder joint strength, parts being soldered must be held in place until the solder solidifies.

If possible apply the solder to the upper portion of the joint so that the work surfaces and not the iron will melt the solder, and so that gravity will aid the solder flow. Selecting cored solder of the proper diameter will aid in controlling the amount of solder being applied to the joint. Use a small gauge for a small joint, and a large gauge for a large joint.

POST SOLDER CLEANING

When cleaning is required, flux residue should be removed as soon as possible, but no later than one hour after soldering. Some fluxes may require more immediate action to facilitate adequate removal. Mechanical means such as agitation, spraying, brushing, and other methods of applications may be used in conjunction with the cleaning solution.

The cleaning solvents, solutions and methods used should not have affected the parts, connections, and materials being cleaned. After cleaning, boards should be adequately dried.

RESOLDERING

Care should be taken to avoid the need for resoldering. When resoldering is required, quality standards for the resoldered connection should be the same as for the original connection.

A cold or disturbed solder joint will usually require only reheating and reflowing of the solder with the addition of suitable flux. If reheating does not correct the condition, the solder should be removed and the joint resoldered.

WORKMANSHIP

Solder joints should have a smooth appearance. A satin luster is permissible. The joints should be free from scratches, sharp edges, grittiness, looseness, blistering, or other evidence of poor workmanship. Probe marks from test pins are acceptable providing that they do not affect the integrity of the solder joint.

An acceptable solder connection should indicate evidence of wetting and adherence when the solder blends to the soldered surface. The solder should form a small contact angle; this indicates the presence of a metallurgical bond and metallic continuity from solder to surface. (See Figure 4).

Smooth clean voids or unevenness on the surface of the solder fillet or coating are acceptable. A smooth transition from pad to component lead should be evident.

OUTLINE

This procedure covers the basic concepts for preparing PC boards and soldering tools for soldering and component removal.

NOTE

Refer to 7.1.1 Soldering Basics before proceeding.

REFERENCES

- 1.0 Foreword
- 2.1 Handling Electronic Assemblies
- 2.2 Cleaning
- 2.5 Baking and Preheating
- 7.1.1 Soldering Basics

TOOLS & MATERIALS

Cleaner
Cleaning Wipes
Flux
Microscope
Solder Braid, Various Sizes
Soldering Iron with Tips
Solder Removal Tool, Extractor Type

CAUTION

Silicon based lubricants or hand creams should not be used on or near surfaces to be soldered.

SOLDERING IRON TIP SELECTION

The size and shape of the soldering iron tip will have an effect on the rate of heat transfer. Larger tips with more surface area will transfer heat faster than smaller tips.

Tip size is based on the size of the component. While there is no exact rule about how the size of a soldering iron tip should compare to the size of the termination, if the tip extends too far beyond the edges of the joint, it could come in contact with another component or the surface of the board. Where possible, the width of the soldering iron tip should be slightly smaller than the width of the pad.

COMPONENT REMOVAL TIP SELECTION

The size and shape of the component removal tip will have an effect on the rate of heat transfer. Larger tips with more surface area will transfer heat faster than smaller tips.

1. Vacuum Desoldering Tip Selection

The smallest tip should be selected providing that the tip fits over the component lead and allows room for molten solder and air to pass through it. The outside diameter of the tip should not cover the pad completely or touch the PC board base material or solder mask. If the tip extends too far beyond the edges of the joint, it could come in contact with another component or the surface of the PC board.

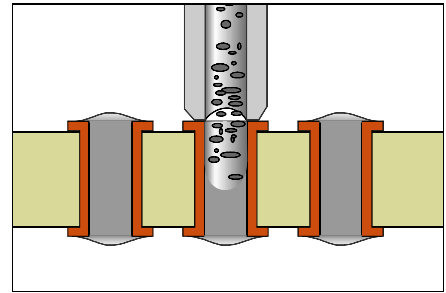

Figure 1: Remove excess solder from plated holes using a vacuum desoldering tool.

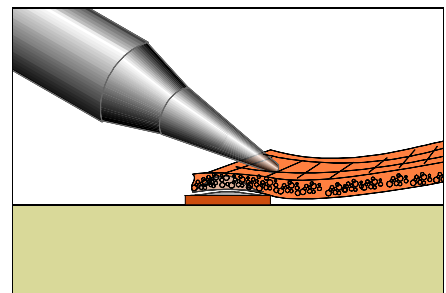

Figure 2: Remove excess solder from surface mount pads using a solder iron and solder braid.

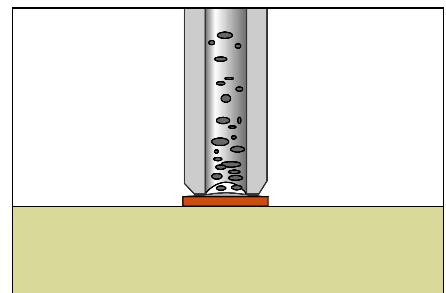

Figure 3: Remove excess solder from surface mount pads using a vacuum desoldering tool.

2. Hot Air Tool Tip Selection

The smallest tip should be selected providing that the proper air flow is delivered to the leads and solder joints. If the tip is too large it may extend beyond the edges of the component and cause reflow to adjacent components or burn the surface of the PC board.

3. Conductive Tool Tip Selection

The smallest tip should be selected providing that the tip fits over the entire component and contacts all the leads evenly. If the tip is too large it may extend beyond the edges of the component and contact another component or the surface of the PC board.

GENERAL PREPARATION

1. If needed, PC boards should be cleaned prior to soldering and component removal operations. Oxidation and contamination should be removed by methods that do not damage leads or parts, and do not cause contamination or hinder solder wetting.
2. If required, PC boards should be baked in a suitable oven to remove any absorbed moisture. Time between bake and soldering should not exceed 5 days, depending on atmosphere humidity levels. Temperature and time of baking is to be determined on individual basis.
3. If needed, tin component leads prior to soldering.
4. If needed, reform component leads or replace the component if the leads do not meet the specification required.

PREPARATION - EXCESS SOLDER

Before inserting a component into a plated through hole for through hole soldering, or onto pads for surface mount soldering, it may be necessary to remove any excess solder. This is recommended for 2 main reasons:

- A. If a component was previously soldered at the rework location, some of the original solder will remain attached to the pad. That solder has already been heated twice. If it becomes part of the new solder joint, it will have been heated at least three or even four times. Reheating solder three or four times - even with the addition of flux - may affect the physical composition of the metals. Every time that solder is reheated, the molecular structure tends to become increasingly brittle.

Solder needs to remain ductile in order to absorb the stresses of expansion and contraction caused by heating and cooling. Old solder should be removed and replaced with new solder whenever a component is reattached.

- B. Excess solder in a plated through hole or excess solder on surface mount pads may interfere with the proper placement of the new component.

PROCEDURE

Plated Through Hole Preparation, Vacuum Desolder Tool Method

Solder removal by wicking is not recommended for removal of solder from a plated hole. A powered vacuum desoldering tool is recommended.

The powered vacuum desoldering tool has a heated tip with a hole in the center to vacuum melted solder away. There are different tip sizes depending on the size of the job. The diameter of the tip should match the width of the pad. A larger tip will extend over the edge of the pad and could potentially burn the board.

1. If needed, clean the area.
2. Inspect the hole. If there is not sufficient solder covering the pad to provide for proper heat transfer, the hole should be filled with solder. Filling the hole improves the thermal linkage between the desolder tool tip and the solder in the hole. This ensures a rapid melt and reduces potential for pad or hole damage.
3. Place the heated desoldering tip onto the pad until you feel the solder melt. Do not apply any downward or sideways pressure on the pad.
4. After the solder melts, activate the vacuum and suck the solder through the hole in the tip into the solder storage chamber. (See Figure 1).

It should only take a few seconds for all of the solder to be removed. After the solder is vacuumed from the hole, lift the tool. Continue the vacuum for an additional few seconds to make sure that the solder has had enough time to travel through the tip into the storage chamber.

5. If needed, remove solder from the remaining holes so that the component can be inserted without force.
6. Clean the area.

Surface Mount Pad Preparation, Solder Braid Method

Solder Braid is made from stranded copper with a powdered flux inside the copper strands. Solder braid will absorb the solder when heat is applied to the braid and solder surface.

1. Solder braid comes in different widths. Select a size that matches the width of the pad, or just slightly smaller, where possible.

NOTE

Most solder removal braid comes with a powdered flux inside the copper strands. Adding additional flux will help to transfer the heat faster and helps to improve the wicking or capillary action of the copper braid.

2. Select a soldering iron tip to match the width of the pad. If the tip is too large for the braid, it will hang over the edges and could burn the board or the solder mask. If the tip is too small, it will take much longer to heat up the braid.
3. Add a small amount of liquid flux to the braid.
4. Place braid over the pad and rest the iron tip on the braid. (See Figure 2). As you apply the heat, it's important to avoid putting any downward or sideways pressure on the pad, since the adhesive resin underneath the pad is being heated at the same time. Adhesion between the PC board and the pad is at its weakest when heated. Sideways pressure against the pad can lift the pad off the PC board surface.

The weight of the soldering iron should apply sufficient contact to quickly heat the solder braid. The heat that passes through the braid should melt any solder that remains on the pad within a few seconds.

The wicking action of the copper will draw the solder away from the pad. This wicking action should be visible. When the wicking action stops, remove the braid and the iron. The used portion of the braid should be clipped off and any other pads should be prepared exactly like the first.

Surface Mount Pad Preparation, Vacuum Desolder Tool Method

The powered vacuum desoldering tool has a heated tip with a hole in the center to vacuum melted solder away. There are different tip sizes depending on the size of the job. The diameter of the tip should match the width of the pad. A larger tip will extend over the edge of the pad and could potentially burn the board.

1. Apply a small amount of liquid flux to the pad.
2. Place the heated tip onto the pad until you feel the solder melt. Do not apply any downward or sideways pressure on the pad, the weight of the handpiece tip is sufficient.

CAUTION

Avoid exerting any pressure on the pad.

3. After the solder melts, activate the vacuum and suck the solder through the hole in the tip into the solder storage chamber. (See Figure 3).

It should only take a few seconds for all of the solder to be removed. After the solder is vacuumed from the pad, lift the tool. Continue the vacuum for an additional few seconds to make sure that the solder has had enough time to travel through the tip into the storage chamber.

4. Any other pads should be prepared exactly like the first.
5. Clean the area.

OUTLINE

This document includes figures and tables for solder joint acceptability criteria on a variety of component types.

NOTE

For the most up to date information on solder joint acceptability criteria refer to:

IPC-A-610 Acceptability of Electronic Assemblies

J-STD-001 Requirements for Soldered Electrical and Electronic Assemblies

REFERENCES

1.0 Foreword

7.1.1 Soldering Basics

7.1.2 Preparation For Soldering And Component Removal

Figure 1: Dimensional Criteria for Through Hole Components

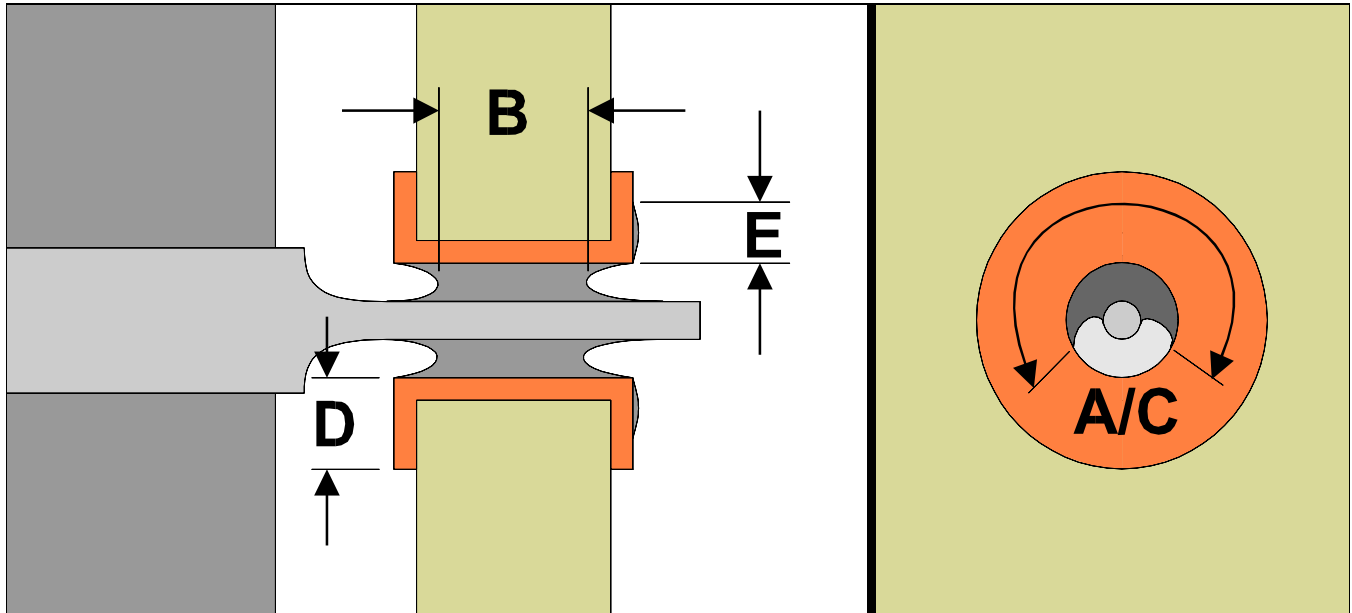

Table 1: Acceptable Solder Criteria for Through Hole Components

Feature	Dim	Class 1	Class 2	Class 3
Circumferential wetting on solder destination side of lead and barrel	A	Not Specified	180°	270°
Vertical Fill of Solder ²	B	Not Specified	75%	75%
Circumferential fillet and wetting on solder source side	C	270°	270°	330°
Percentage of original land area covered with wetted solder on solder destination side.	D	0	0	0
Percentage of original land area covered with wetted solder - solder source side.	E	75%	75%	75%

NOTES

1. Wetted solder refers to solder applied by the solder process.
2. The 25% unfilled volume includes both source and destination side depressions.

Figure 2: Dimensional Criteria for Chip Components

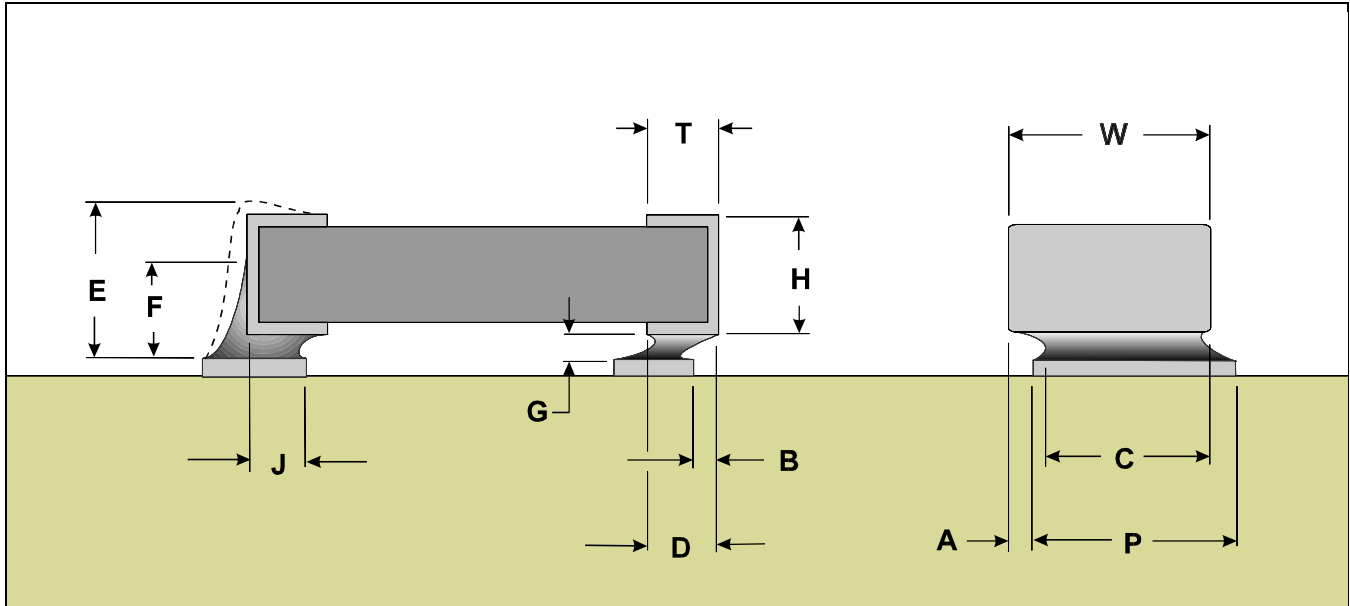

Table 2: Acceptable Solder Criteria for Through Hole Components

Feature	Dim	Class 1	Class 2	Class 3
Maximum Side Overhang	A	1/2W or 1/2P or 1.50 mm (.060") whichever is less	1/2W or 1/2P or 1.50 mm (.060") whichever is less	1/4W or 1/4P or 1.50 mm (.060") whichever is less
Maximum End Overhang	B	Not permitted	Not permitted	Not permitted
Minimum End Joint Width	C	1/2W or 1/2P whichever is less	1/2W or 1/2P whichever is less	3/4W or 3/4P whichever is less
Minimum Side Joint Length	D	Not required	Not required	Not required
Maximum Fillet Height	E	See Note 1	See Note 1	See Note 1
Minimum Fillet Height	F	See Note 2	G + 1/4H or 0.50 mm (.020") whichever is less	G + 1/4H or 0.50 mm (.020") whichever is less
Minimum Thickness	G	See Note 2	See Note 2	0.2 mm (.008") (See Note 3)
Minimum End Overlap	J	Required	Required	Required

Notes:

1. The maximum fillet may overhang the land or extend onto the top of the chip cap metallization; however the solder shall not extend further onto the component body.
2. Properly wetted fillet evident.
3. Unless satisfactory cleaning can be demonstrated with reduced clearance.

Figure 3: Dimensional Criteria for J Lead Components

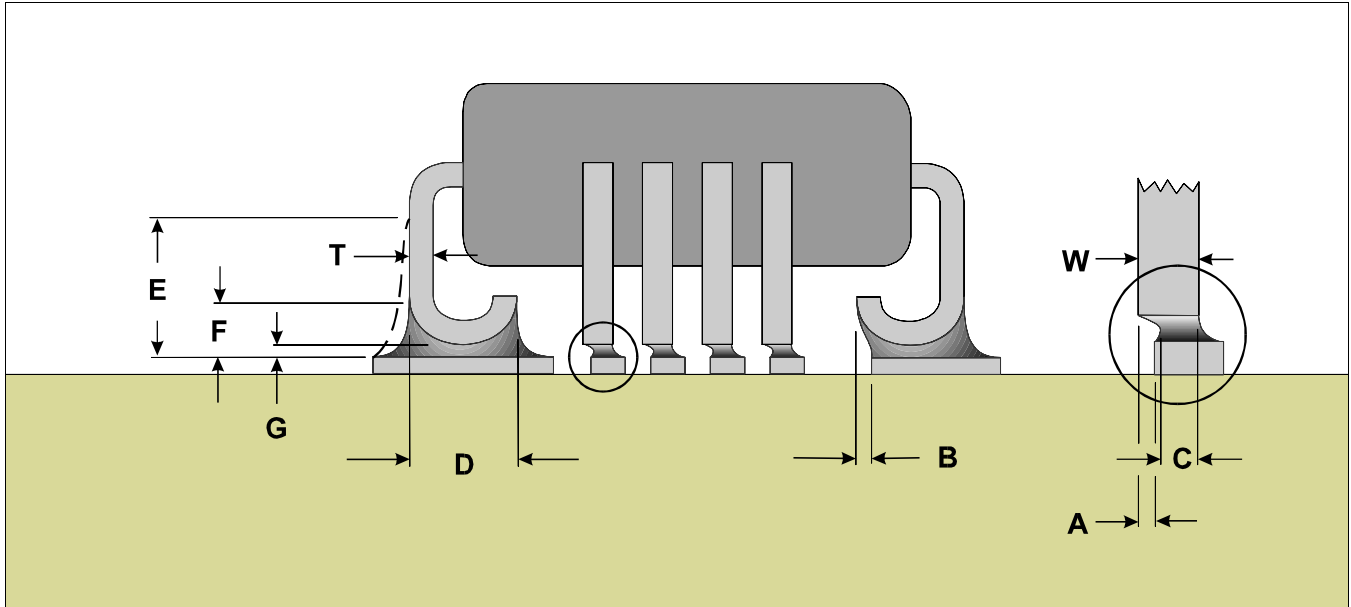

Table 3: Acceptable Solder Criteria for J Lead Components

Feature	Dim	Class 1	Class 2	Class 3
Maximum Side Overhang	A	1/2W	1/2W	1/4W
Maximum Toe Overhang	B	Unspecified	Unspecified	Unspecified
Minimum End Joint Width	C	See Note 2	W - A	W - A
Minimum Side Joint Length	D	See Note 2	1 1/2 W	1 1/2 W
Maximum Fillet Height	E	See Note 1	See Note 1	See Note 1
Minimum Heel Fillet Height	F	See Note 2	G + 1/2 T	G + T
Minimum Thickness	G	See Note 2	See Note 2	See Note 2

Notes:

1. The maximum solder fillet shall not touch package body.
2. Properly wetted fillet evident.

Figure 4: Dimensional Criteria for Gull Wing Components

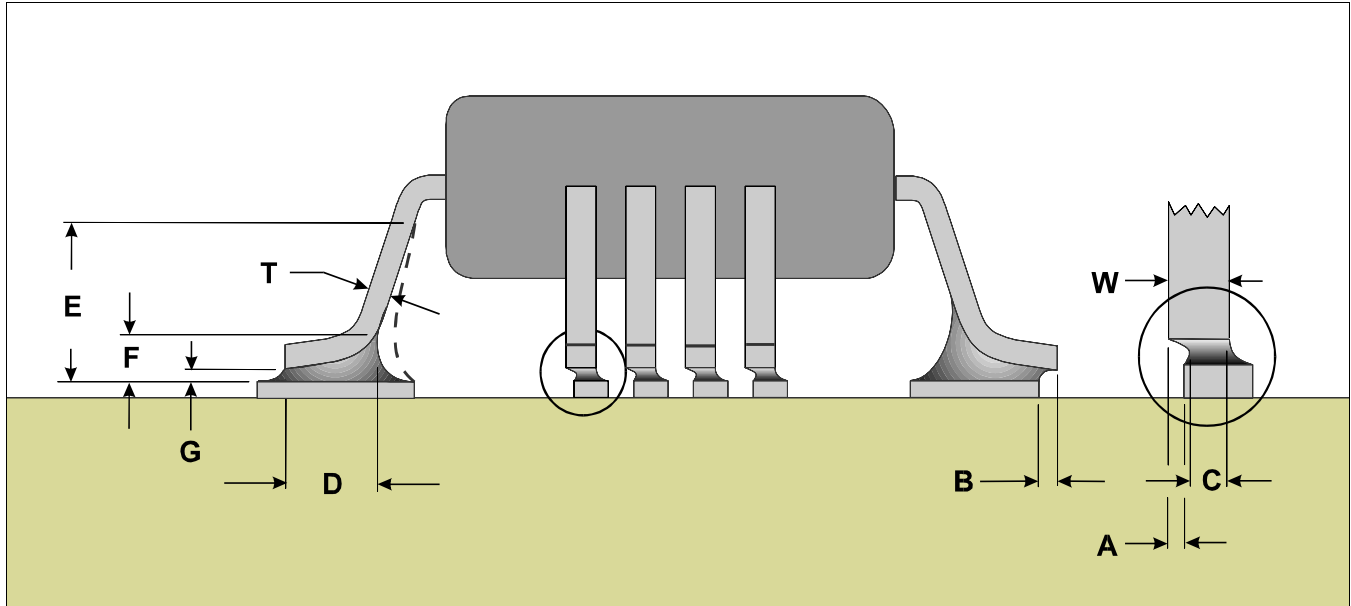

Table 4: Acceptable Solder Criteria for Gull Wing Components

Feature	Dim	Class 1	Class 2	Class 3
Maximum Side Overhang	A	1/2W or 0.50 mm (.020") whichever is less	1/2W or 0.50 mm (.020") whichever is less	1/4W or 0.50 mm (.020") whichever is less
Maximum Toe Overhang	B	Note 2	Note 2	Note 2
Minimum End Joint Width	C	1/2 W	W - A	W - A
Minimum Side Joint Length	D	W or 0.50 mm (.020") whichever is less	W	W
Maximum Heel Fillet Height	E	See Note 3	See Note 1	See Note 1
Minimum Heel Fillet Height	F	See Note 3	G + 1/2 T	G + T
Minimum Thickness	G	See Note 3	See Note 3	See Note 3

Notes:

1. Solder fillet may extend through the top bend. Solder must not touch the package body or end seal, except for low profile SMD devices, e.g., SOICs, SOTs. Solder should not extend under the body of low profile surface mount components whose leads are made of Alloy 42 or similar metals.
2. Must not violate minimum design conductor spacing.
3. Properly wetted fillet evident.

Point To Point Method

OUTLINE

This procedure covers the general guidelines for soldering through hole components using a point to point soldering method. There is basically only one style of through hole component. Whether there are a few leads or many or whether the component is large or small the soldering principles are the same.

REFERENCES

- 1.0 Foreword
- 2.1 Handling Electronic Assemblies
- 2.2 Cleaning
- 2.5 Baking and Preheating
- 7.1.1 Soldering Basics
- 7.1.2 Preparation For Soldering And Component Removal
- 7.1.3 Solder Joint Acceptability Criteria

TOOLS & MATERIALS

Cleaner
Cleaning Wipes
Flux
Microscope
Soldering Iron with Tips
Solder

PROCEDURE

1. If needed, form the component and clean the area.
2. Insert the component into the plated hole. If needed, secure in place by bending leads or other mechanical means.
3. If needed, apply liquid flux to the plated holes and pads.
4. Place the soldering iron tip at the junction between the pad and component lead. Apply a small amount of solder at the junction of soldering iron tip and lead to make a solder bridge. (See Figure 1).

NOTE

The size of the solder is important when soldering small components. If the solder is too large, it is easy to melt too much solder into the joint. If the solder is too small, it can take too long to melt the optimum amount into the joint.

CAUTION

Avoid exerting any pressure on the pad.

5. Immediately feed solder into the joint from the side opposite from the soldering iron tip until the proper fillet is achieved. Remove the solder then remove the iron. The iron may be swept over the end of the component lead to cover it with solder. (See Figure 2).

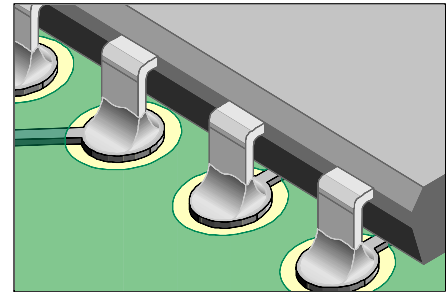

Through Hole Component

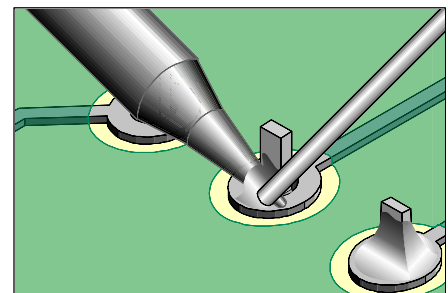

Figure 1: Apply solder at the junction of soldering iron tip and lead to make a solder bridge.

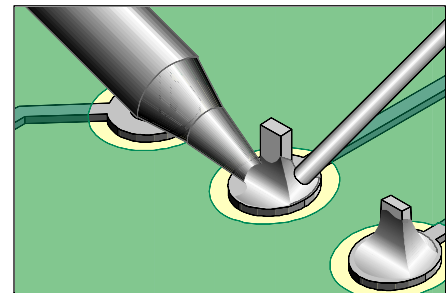

Figure 2: Feed solder into the joint from the side opposite from the iron tip until the proper fillet is achieved.

Point To Point Method

NOTE

Apply the solder to the side opposite from the soldering iron tip so that the work surfaces and not the iron will melt the solder.

6. On multiple lead components solder the opposite corners first to stabilize the component. Follow by soldering the remaining leads in a random pattern to reduce excessive heat buildup in one area.
7. Clean the flux residue, if required and inspect.

OUTLINE

This procedure covers the general guidelines for through hole component removal using a solder fountain system.

There is basically only one style of through hole component. Whether there are a few leads or many or whether the component is large or small the component removal principles using this method are the same.

CAUTION - Operator Safety

This process uses molten solder and exposes the untrained operator to serious hazards. A thorough review of the equipment manual and comprehensive training are mandatory. Daily maintenance is essential. Consult the equipment manual for more information.

CAUTION - Component Sensitivity

This method may subject the component to extreme temperatures. Evaluate the component's tolerance to heat prior to using this method.

CAUTION - PC Board Sensitivity

PC Boards are made from a great variety of materials. When subjected to the high temperatures of the molten solder used in this method they are susceptible to the following types of damage:

1. Layer delamination.
2. Copper delamination, separation of pads, barrels of inner layers.
3. Burns and solder mask chipping.
4. Warp.

Each PC board must be treated individually and scrutinized carefully for its reaction to heat. If a series of PC boards are to be reworked, the first several should be fully protected until a reliable procedure is established.

REFERENCES

- 1.0 Foreword
- 2.1 Handling Electronic Assemblies
- 2.2 Cleaning
- 2.5 Baking and Preheating
- 7.1.1 Soldering Basics
- 7.1.2 Preparation For Soldering And Component Removal
- 7.1.3 Solder Joint Acceptability Criteria

TOOLS & MATERIALS

Cleaner
Cleaning Wipes
Extractor/Insertion Tools
Flexible Mask
Flux
Microscope
Oven
Solder
Solder Fountain System
Soldering Iron with Tips
Tape, High Temperature

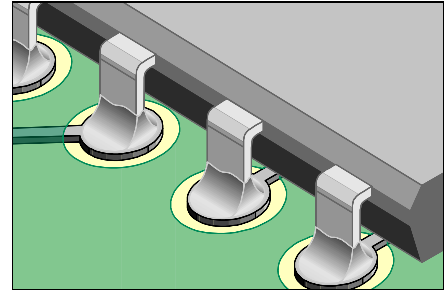

Through Hole Component



Typical solder fountain system.

Solder Fountain System

Most solder fountain systems have the same basic components. A solder pump and solder reservoir, various nozzle sizes, controls for solder flow height, solder temperature and timers.

Solder from the reservoir is driven up through the nozzle by the pump. Nozzles are made of steel with welded seams and connections. It is important that the nozzle construction allow for the capture of the pump's inflow and for the runoff of the solder. This prevents the excess splashing and maintains a usable solder level above the nozzle lip.

Occasionally the opening in the solder fountain table needs to be restricted to prevent solder splash from contaminating the un-worked part of the board. Do not close the opening too tight or you may impede the nozzle run off.

Above the solder fountain head there is generally a light projected alignment mark that permits you to center the part to be removed over the nozzle.

Solder Height Adjustment

Solder height should be set at 1.50 mm - 3.00 mm (.060" - .120") above the lip of the nozzle. The ideal situation is to have the leads of a component just immersed and wetted without having the wave exert any upward pressure on the PC board. The solder fountain table surface should be parallel to the nozzle surface. Components and leads on the bottom side of the PC board may cause the PC board to be uneven, this condition must be compensated for.

Insufficient immersion will prevent proper heat transfer and reflow. Excess pressure will cause solder to surge up through holes and to spill out onto the top side of the PC board.

Solder Temperature Adjustment

Solder temperature adjustment varies depending on several factors. The normal setting is 260°C (500° F). During heavy use, solder temperature may cycle between 250°C - 270°C (480°F - 520° F). The heaters should react quickly to normal drops in temperature. The heaters may overshoot the preset temperature when vigorous activity is suddenly halted. Operators must be alert to temperature fluctuations that exceed preset standards.

Solder Fountain Time Adjustment

This adjustment can be used to precisely control operations of a repetitive nature or in instances where you want to strictly control a PC board's exposure to the solder fountain heat.

The timer may also be set to maximum and the on/off action of the wave is controlled by the motor's on/off foot pedal or by lifting the board on and off the wave.

Removal Tool

There are a variety of removal tools to help extract the component once reflow has been achieved. The extractor tool should provide the

operator a good grip but should not unduly damage the component during removal.

PC Board Pre-heat

Recommendations for pre-heat range from 1 to 4 hours at 65°C - 120°C (150°F - 250°F). The requirements of temperature and time for pre-heat depend on the board construction, age and exposure to the atmosphere.

In general terms the pre-heat will serve four purposes.

1. To drive out volatiles or moisture from the PC board. Moisture that has penetrated the board may cause expansion or delamination when it is rapidly heated.
2. To prevent thermal shock to the board. Ambient temperature in buildings in the winter can be as low as 13°C (55°F). As the PC board at this temperature comes in contact with molten solder, the extreme shock of the widely varying temperature may cause surface or internal damage.
3. Pre-heat may permit you to pre expand the PC board. Some PC boards expand so severely at the point of high heat that they will bow up or down enough to create difficulties in maintaining proper board profile to the solder wave.
4. Pre-heat raises the temperature of the PC board and the component to be removed. This allows for quicker component removal. This reduces the potential for burning of solder mask and the PC board surface and reduces potential for other thermal damage.

PROCEDURE - PC Board Preparation

The area surrounding the component to be removed may need protection. If components or the PC board surface are susceptible to damage or exposure to solder they may be protected by using the following procedure:

1. Straighten any leads that may prevent the easy removal of the part.
2. Apply Kapton tape to any flat surfaces surrounding the rework area. This tape will insulate the surface from extreme temperatures or apply high temperature flexible mask to protect irregular surfaces. The mask may need baking to provide the proper cure prior to reflow.
3. Select an extractor tool and check the fit to be sure the component can be grabbed easily.

PROCEDURE - PC Board Pre-heat

PC Boards returned from the field or where they have been exposed to moisture for some time.

1. Bake for 4 hours at approximately 75°C (165°F).
Prior to part removal PC board should be pre-heated for one hour prior to removal of the part. If possible perform reflow immediately upon removal of the PC board from the oven after completion of the

baking cycle. If the PC board must sit between the pre-heat and removal, it may sit for the maximum of one night only in a dry atmosphere.

2. Top heat during removal is only used when working with the most difficult components. To apply top heat, a heat gun is positioned directly above the solder nozzle at a set distance above the PC board surface. Top heat is applied for a set time prior to activating the solder fountain. Heat sensitive chalk applied to the component will signal when the proper temperature has been achieved.

PROCEDURE - Installation Process

1. Preform component leads if needed, and test on a practice board to be sure leads are properly aligned.
2. If the holes in the PC board are clear, insert the component. If needed, secure in place by bending leads or other mechanical means.
3. Turn on the solder fountain system and allow the solder to reach the proper operating temperature. Clean the machine as needed and test run the pump to be sure there is no buildup of contamination that may cause a drag on the pumping system.
4. Select the proper nozzle and place it into the bath of the solder fountain system. A nozzle that is too large will expose the PC board surface to unnecessary heat. A nozzle that is too small may not reflow all the component leads.
5. Check the table height and solder wave height to be sure they are properly set for the PC board to be worked on.
6. Apply liquid flux to all the solder filled holes or to the component leads if the component has been inserted into open holes. Apply the flux to both the top and bottom side.
7. Place the PC board over the nozzle. Check the position using the alignment light.
8. Activate the solder fountain. Once full solder reflow has been achieved insert the component, if not already in place. A great deal of operator skill and experience are required to expect good results when inserting the component during the solder fountain cycle.
9. Immediately drop the solder fountain wave to prevent over exposure.
10. Allow the PC board to cool before handling and inspection.
11. Clean the area and inspect for signs of damage.

Point To Point Method

OUTLINE

This procedure covers the general guidelines for soldering surface mount chip components. The following surface mount chip components are covered by this procedure. While all of these components are different, the techniques for soldering are relatively similar

Chip Resistors

The component body of chip resistors is made out of alumina; an extremely hard, white colored material. The resistive material is normally located on the top. Chip resistors are usually mounted with the resistive element facing upwards to help dissipate heat.

Ceramic Capacitors

These components are constructed from several layers of ceramic with internal metallized layers. Because metal heats up much faster than ceramic, ceramic capacitors need to be heated slowly to avoid internal separations between the ceramic and the metal layers. Internal damage will not generally be visible, since any cracks will be inside the ceramic body of the component.

NOTE

Avoid rapid heating of ceramic chip capacitors during soldering operations.

Plastic Body

Another style of chip component has a molded plastic body that protects the internal circuitry. There are a number of different types of components that share this type of exterior package. The termination styles for plastic chip component packages vary considerably.

MELF

MELF - Metal Electrode Face cylindrical components. These may be capacitors, resistors, and diodes. It can be hard to tell them apart - since there is no universal coloring or component designators printed on the component bodies.

REFERENCES

- 1.0 Index
- 2.1 Handling Electronic Assemblies
- 2.2 Cleaning
- 2.5 Baking and Preheating
 - 7.1.1 Soldering Basics
 - 7.1.2 Preparation For Soldering And Component Removal
 - 7.1.3 Solder Joint Acceptability Criteria

TOOLS & MATERIALS

Cleaner
Cleaning Wipes
Flux
Microscope System
Soldering Iron with Tips
Solder

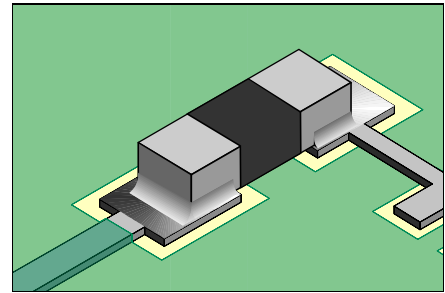

Surface Mount Chip Component

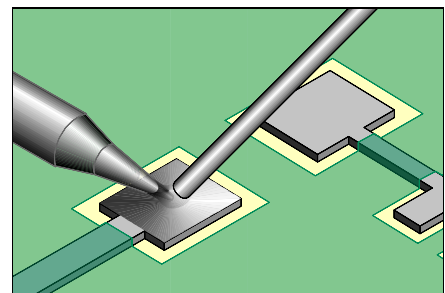

Figure 1: Prefill one pad with solder.

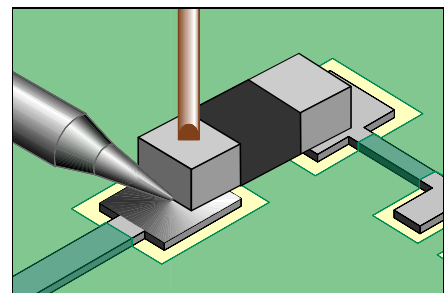

Figure 2: Place the soldering iron tip at the junction between the prefilled pad and component lead.

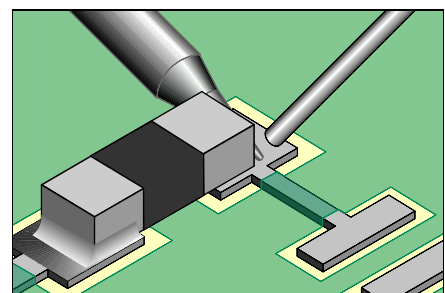

Figure 3: Solder the other opposite side of the component.

Point To Point Method

Product Class: R/F/W/C ■ Skill Level: Intermediate ■ Conformance Level: High

Revision C ■ Page 2 of 2

PROCEDURE

1. Add liquid flux to one pad.
2. Prefill one pad with solder. (See Figure 1).
3. Clean the area.
4. Add liquid flux to both pads.
5. Place the component in position and hold it steady with a wooden stick or tweezers so that the soldering iron won't push the component out of alignment.
6. Place the soldering iron tip at the junction between the prefilled pad and component lead. Flow the solder until the component drops down and is soldered in position. Apply additional solder as needed. (See Figure 2).
7. Remove the tip. Wait a moment for the solder to solidify before soldering the other side of the component. (See Figure 3).
8. Clean, if required and inspect.

Hot Gas Method

Product Class: R/F/W/C ■ Skill Level: Intermediate ■ Conformance Level: High

Revision C ■ Page 1 of 2

OUTLINE

This procedure covers the general guidelines for soldering surface mount chip components. The following surface mount chip components are covered by this procedure. While all of these components are different, the techniques for soldering are relatively similar

Chip Resistors

The component body of chip resistors is made out of alumina; an extremely hard, white colored material. The resistive material is normally located on the top. Chip resistors are usually mounted with the resistive element facing upwards to help dissipate heat.

Ceramic Capacitors

These components are constructed from several layers of ceramic with internal metallized layers. Because metal heats up much faster than ceramic, ceramic capacitors need to be heated slowly to avoid internal separations between the ceramic and the metal layers. Internal damage will not generally be visible, since any cracks will be inside the ceramic body of the component.

NOTE

Avoid rapid heating of ceramic chip capacitors during soldering operations.

Plastic Body

Another style of chip component has a molded plastic body that protects the internal circuitry. There are a number of different types of components that share this type of exterior package. The termination styles for plastic chip component packages vary considerably.

MELF

MELF - Metal Electrode Face cylindrical components. These may be capacitors, resistors, and diodes. It can be hard to tell them apart - since there is no universal coloring or component designators printed on the component bodies.

REFERENCES

- 1.0 Index
- 2.1 Handling Electronic Assemblies
- 2.2 Cleaning
- 2.5 Baking and Preheating
 - 7.1.1 Soldering Basics
 - 7.1.2 Preparation For Soldering And Component Removal
 - 7.1.3 Solder Joint Acceptability Criteria

TOOLS & MATERIALS

Cleaner
Cleaning Wipes
Flux
Hot Air Tool with Tips

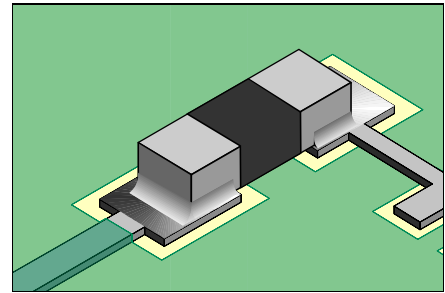

Surface Mount Chip Component

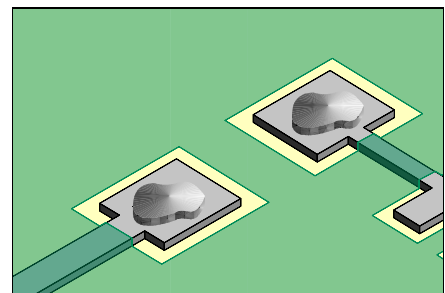

Figure 1: Add a small bead of solder paste to each pad.

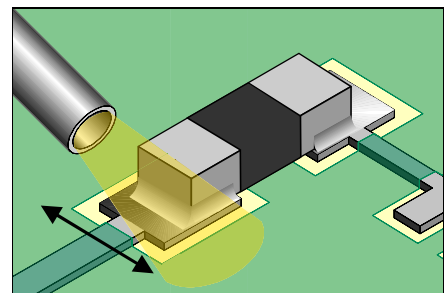

Figure 2: Move the tool back and forth to heat both solder joints until complete solder melt is observed.

Hot Gas Method

Product Class: R/F/W/C ■ Skill Level: Intermediate ■ Conformance Level: High

Revision C ■ Page 2 of 2

Microscope

Solder

PROCEDURE

1. Add a small bead of solder paste to each pad. (See Figure 1).
2. Place the component in position.
3. Adjust the pressure and temperature output of the hot air tool.
4. Direct the hot air over the component with the hot air tool tip approximately 2.50 cm (1.00") from the solder joint. This initial heating will pre-dry the solder paste.

NOTE

When the solder paste has pre-dried, the paste will have a dull flat appearance

5. When the solder paste has dried, move the hot air tool tip to approximately 0.50 cm (0.20") above the component. Move the tool back and forth to heat both solder joints until complete solder melt is observed. (See Figure 2).
6. Remove the tool. Wait a moment for the solder to solidify.
7. Clean, if required and inspect.

Point To Point Method

OUTLINE

This procedure covers the general guidelines for soldering surface mount J lead components. There is basically only one style of J lead component. Whether leads are on two sides or four sides, or whether the component is large or small, the soldering principles are the same.

REFERENCES

- 1.0 Index
- 2.1 Handling Electronic Assemblies
- 2.2 Cleaning
- 2.5 Baking and Preheating
- 7.1.1 Soldering Basics
- 7.1.2 Preparation For Soldering And Component Removal
- 7.1.3 Solder Joint Acceptability Criteria

TOOLS & MATERIALS

- Cleaner
- Cleaning Wipes
- Flux
- Microscope
- Solder
- Soldering Iron with Tips

PROCEDURE

1. Add liquid flux to the corner pads.
2. Place the component in position and hold it steady. The leads must be aligned with the pads. On large components this is best done by aligning the leads on opposite corners. (See Figure 1).
3. Place the soldering iron tip at the junction between the pad and component lead at one of the corners. Apply additional solder as needed. (See Figure 2).
4. Remove the tip. Wait a moment for the solder to solidify before soldering the opposite corner.
5. After the opposite corner is soldered, solder the remaining leads.
6. Clean, if required and inspect.

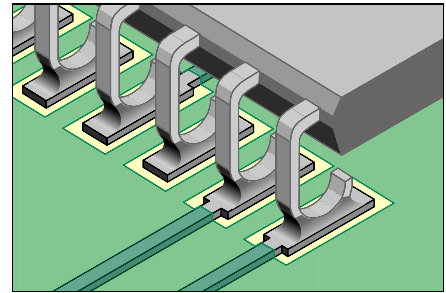

**Surface Mount
J Lead Component**

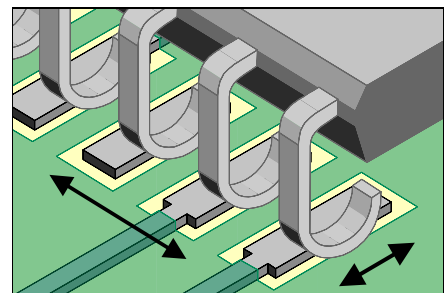

Figure 1: Place component and check alignment.

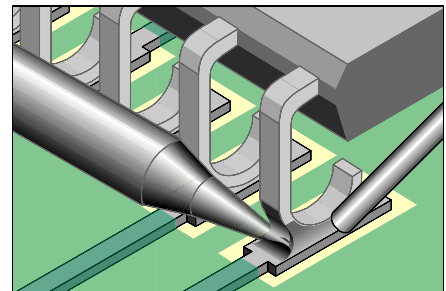

Figure 2: Place the soldering iron tip at the junction between the pad and component lead.

Continuous Flow Method

OUTLINE

This procedure covers the general guidelines for soldering surface mount J lead components. There is basically only one style of J lead component. Whether leads are on two sides or four sides, or whether the component is large or small, the soldering principles are the same.

REFERENCES

- 1.0 Index
- 2.1 Handling Electronic Assemblies
- 2.2 Cleaning
- 2.5 Baking and Preheating
- 7.1.1 Soldering Basics
- 7.1.2 Preparation For Soldering And Component Removal
- 7.1.3 Solder Joint Acceptability Criteria

TOOLS & MATERIALS

- Cleaner
- Cleaning Wipes
- Flux
- Microscope
- Solder
- Soldering Iron with Tips

PROCEDURE

1. Add liquid flux to the corner pads.
2. Place the component in position and hold it steady. The leads must be aligned with the pads. On large components this is best done by aligning the leads on opposite corners. (See Figure 1).
3. Place the soldering iron tip at the junction between the pad and component lead at one of the corners. Apply additional solder as needed.
4. Remove the tip. Wait a moment for the solder to solidify before soldering the opposite corner.
5. Apply solder to the continuous flow solder tip to create a convex bead of molten solder on the tip. (See Figure 2).
6. Position the solder tip so that the solder bead contacts the vertical portion of the J leads. Slowly move the tip over the row of leads to form proper solder fillets at each joint. (See Figure 3).
7. Repeat steps 5 and 6 for the remaining sides.
8. Clean, if required and inspect.

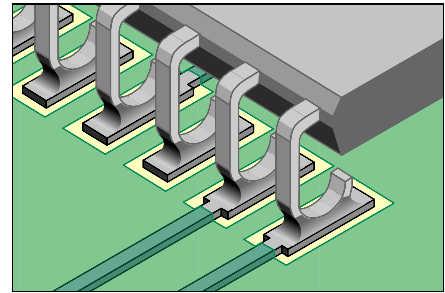

**Surface Mount
J Lead Component**

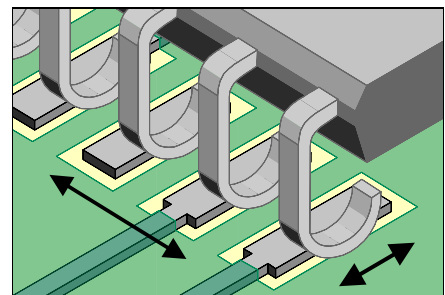

Figure 1: Place component and check alignment.

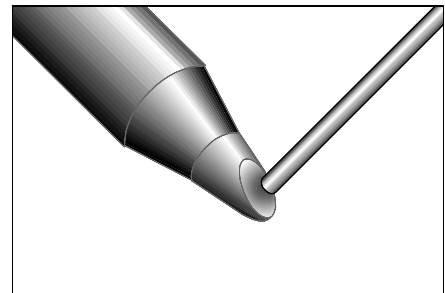

Figure 2: Apply solder to the continuous flow solder tip to create a convex bead of molten solder.

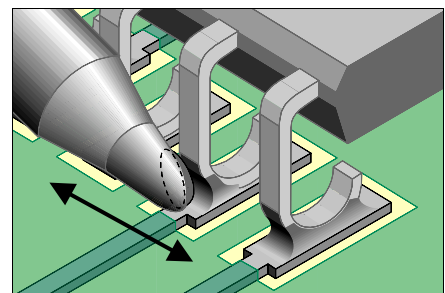

Figure 3: Slowly move the tip over the row of leads to form proper solder fillets at each joint.

Hot Gas Method

Product Class: R/F/W/C ■ Skill Level: Intermediate ■ Conformance Level: High

Revision C ■ Page 1 of 1

OUTLINE

This procedure covers the general guidelines for soldering surface mount J lead components. There is basically only one style of J lead component. Whether leads are on two sides or four sides, or whether the component is large or small, the soldering principles are the same.

REFERENCES

- 1.0 Index
- 2.1 Handling Electronic Assemblies
- 2.2 Cleaning
- 2.5 Baking and Preheating
 - 7.1.1 Soldering Basics
 - 7.1.2 Preparation For Soldering And Component Removal
 - 7.1.3 Solder Joint Acceptability Criteria

TOOLS & MATERIALS

Cleaner
Cleaning Wipes
Flux
Hot Air Tool with Tips
Microscope
Solder Paste

PROCEDURE

1. Add a small bead of solder paste along the row of pads.
(See Fig. 1).
2. Place the component in position.
3. Adjust the pressure and temperature output of the hot air tool.
4. Direct the hot air over the component with the hot air tool tip approximately 2.50 cm (1.00") from the solder joint. This initial heating will pre-dry the solder paste.

NOTE

Solder paste has a dull flat appearance when dried.

5. When the solder paste has dried, move the hot air tool tip to approximately 0.50 cm (0.20") above the component. Move the tool back and forth to heat all the solder joints until complete solder melt is observed. (See Figure 2).
6. Remove the tool. Wait a moment for the solder to solidify.
7. Clean, if required and inspect.

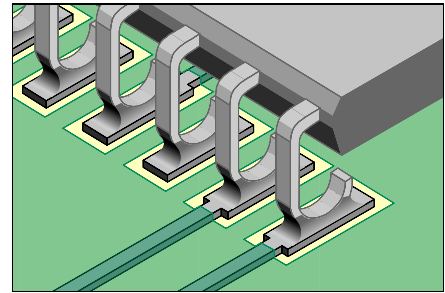

**Surface Mount
J Lead Component**

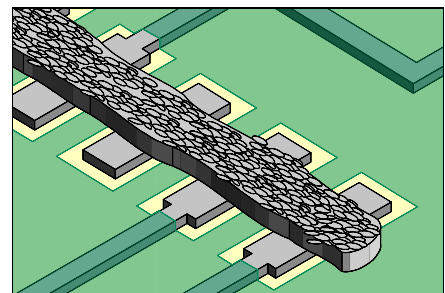

Figure 1: Add a small bead of solder paste along the row of pads.

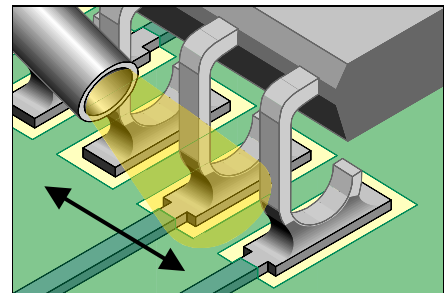

Figure 2: Move the tool back and forth to heat all the solder joints until complete solder melt is observed.

Point To Point Method

OUTLINE

This procedure covers the general guidelines for soldering surface mount Gull Wing components. There is basically only one type of Gull Wing components. Whether leads are on two sides or four sides, or whether the component is large or small, the soldering principles are the same.

REFERENCES

- 1.0 Index
- 2.1 Handling Electronic Assemblies
- 2.2 Cleaning
- 2.5 Baking and Preheating
- 7.1.1 Soldering Basics
- 7.1.2 Preparation For Soldering
- 7.1.3 Solder Joint Acceptability Criteria

TOOLS & MATERIALS

- Cleaner
- Cleaning Wipes
- Flux
- Microscope
- Solder
- Soldering Iron with Tips

PROCEDURE

1. Add liquid flux to the corner pads.
2. Place the component in position and hold it steady. The leads must be aligned with the pads. On large components this is best done by aligning the leads on opposite corners. (See Figure 1).
3. Place the soldering iron tip at the junction between the pad and component lead at one of the corners. The soldering iron tip may rest at the junction of the component lead and pad or on top of the lead. Apply additional wire solder as needed. (See Figure 2).
4. Remove the tip. Wait a moment for the solder to solidify before soldering the opposite corner.
5. After the opposite corner is soldered, solder the remaining leads.
6. Clean, if required and inspect.

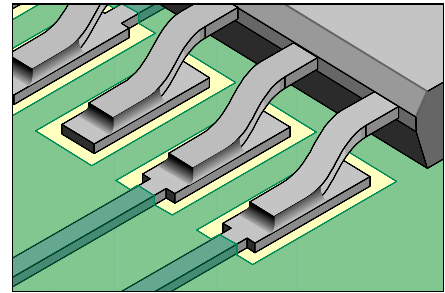

**Surface Mount
Gull Wing Component**

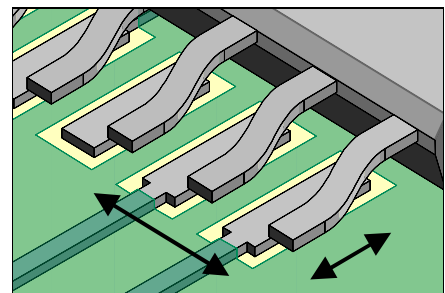

Figure 1: Place component and check alignment.

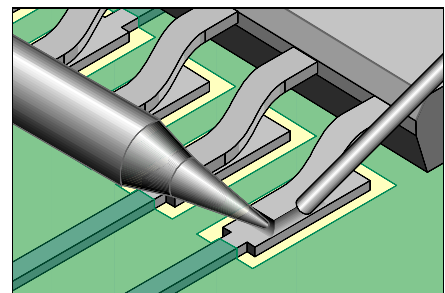

Figure 2: Place the soldering iron tip at the junction between the pad and component lead.

Continuous Flow Method

OUTLINE

This procedure covers the general guidelines for soldering surface mount Gull Wing components. There is basically only one type of Gull Wing components. Whether leads are on two sides or four sides, or whether the component is large or small, the soldering principles are the same.

REFERENCES

- 1.0 Index
- 2.1 Handling Electronic Assemblies
- 2.2 Cleaning
- 2.5 Baking and Preheating
- 7.1.1 Soldering Basics
- 7.1.2 Preparation For Soldering
- 7.1.3 Solder Joint Acceptability Criteria

TOOLS & MATERIALS

- Cleaner
- Cleaning Wipes
- Flux
- Microscope
- Solder
- Soldering Iron with Tips

PROCEDURE

1. Add liquid flux to the corner pads.
2. Place the component in position and hold it steady. The leads must be aligned with the pads. On large components this is best done by aligning the leads on opposite corners. (See Figure 1).
3. Place the soldering iron tip at the junction between the pad and component lead at one of the corners. Apply additional solder as needed.
4. Remove the tip. Wait a moment for the solder to solidify before soldering the opposite corner.
5. Apply solder to the continuous flow solder tip to create a convex bead of molten solder on the tip. (See Figure 2).
6. Position the solder tip so that the solder bead contacts the top portion of the leads. Slowly move the tip over the row of leads to form proper solder fillets at each joint. (See Figure 3).
7. Repeat steps 5 and 6 for the remaining sides.
8. Clean, if required and inspect.

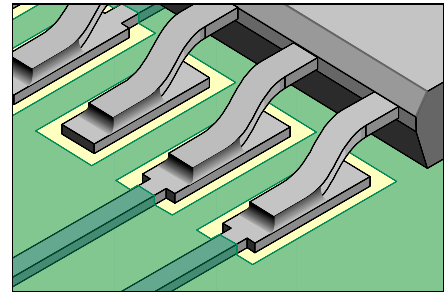

**Surface Mount
Gull Wing Component**

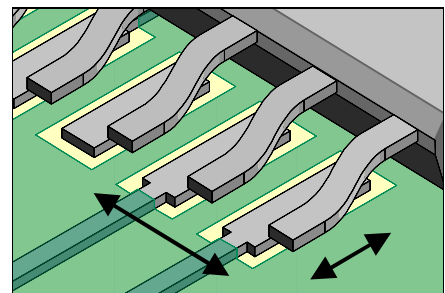

Figure 1: Place component and check alignment.

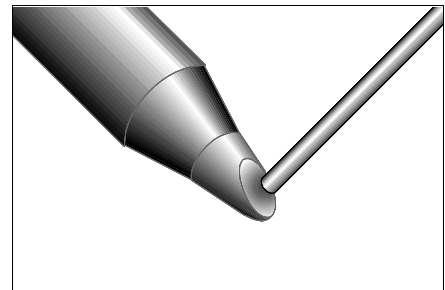

Figure 2: Apply solder to the continuous flow solder tip to create a convex bead of molten solder.

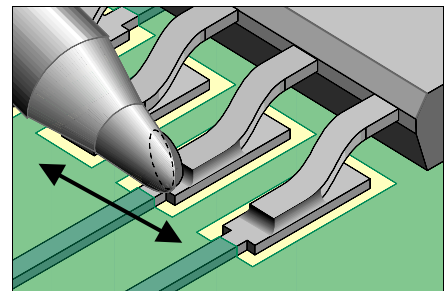

Figure 3: Slowly move the tip over the row of leads to form proper solder fillets at each joint.

Hot Gas Method

Product Class: R/F/W/C ■ Skill Level: Intermediate ■ Conformance Level: High

Revision C ■ Page 1 of 1

OUTLINE

This procedure covers the general guidelines for soldering surface mount Gull Wing components. There is basically only one type of Gull Wing components. Whether leads are on two sides or four sides, or whether the component is large or small, the soldering principles are the same.

REFERENCES

- 1.0 Index
- 2.1 Handling Electronic Assemblies
- 2.2 Cleaning
- 2.5 Baking and Preheating
 - 7.1.1 Soldering Basics
 - 7.1.2 Preparation For Soldering
 - 7.1.3 Solder Joint Acceptability Criteria

TOOLS & MATERIALS

Cleaner
Cleaning Wipes
Flux
Hot Air Tool with Tips
Microscope
Solder Paste

PROCEDURE

1. Add a small bead of solder paste along the row of pads. (See Fig. 1).
2. Place the component in position.
3. Adjust the pressure and temperature output of the hot air tool.
4. Direct the hot air over the component with the hot air tool tip approximately 2.50 cm (1.00") from the solder joint. This initial heating will pre-dry the solder paste.

NOTE

Solder paste has a dull flat appearance when dried.

5. When the solder paste has dried, move the hot air tool tip to approximately 0.50 cm (0.20") above the component. Move the tool back and forth to heat all the solder joints until complete solder melt is observed. (See Figure 2).
6. Remove the tool. Wait a moment for the solder to solidify.
7. Clean, if required and inspect.

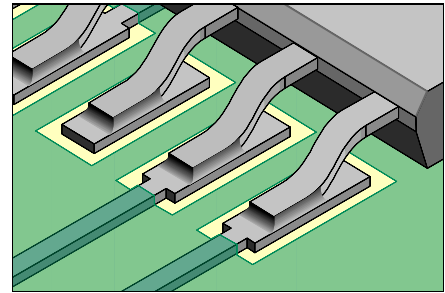

**Surface Mount
Gull Wing Component**

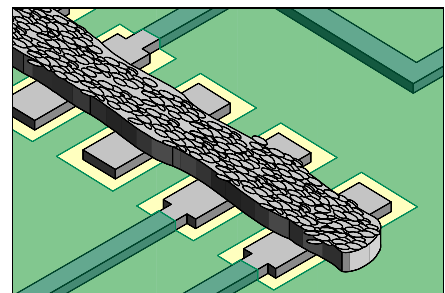

Figure 1: Add a small bead of solder paste along the row of pads.

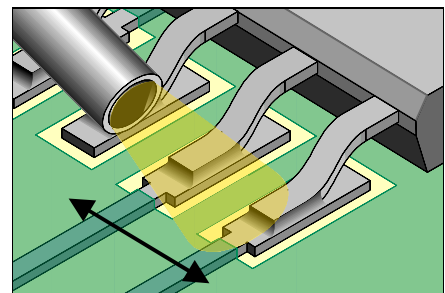

Figure 2: Move the tool back and forth to heat all the solder joints until complete solder melt is observed.

Vacuum Method

OUTLINE

This procedure covers the general guidelines for through hole component removal using a powered vacuum desoldering tool.

There is basically only one style of through hole component. Whether there are a few leads or many, or whether the component is large or small, the component removal principles are the same.

REFERENCES

- 1.0 Foreword
- 2.1 Handling Electronic Assemblies
- 2.2 Cleaning
- 2.5 Baking and Preheating
- 7.1.1 Soldering Basics
- 7.1.2 Preparation For Soldering And Component Removal

TOOLS & MATERIALS

- Cleaner
- Cleaning Wipes
- Flux
- Microscope
- Solder
- Solder Removal Tool, Vacuum Type with Tips
- Soldering Iron with Tips

PROCEDURE - Standard Method

1. Inspect the size of the solder joints on the component to be removed. If the size of the solder joint fillet's are minimal, it may be desirable to add additional solder to form an "excess solder" joint. This will improve the thermal linkage.
2. Apply a small amount of liquid flux to the solder joints of the component to be removed.
3. Align the desolder tip with a component lead end and lightly make contact with the solder joint. Keep the desolder tip off the pad by allowing it to slide around on a film of solder.

CAUTION

Do not apply pressure with the solder extractor tip to the lands or other conductive patterns.

4. After the solder has melted, start a rotating or oscillating motion with the desolder tip. Continue the rotating motion until a change in the "feel" of the rotating motion occurs. At this instant the solder in the solder joint is completely molten. Immediately activate the vacuum, extracting the solder from the solder joint. (See Figure 1).

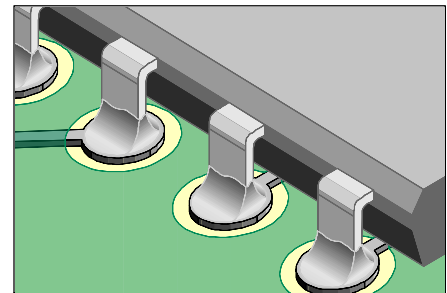

Through Hole Component

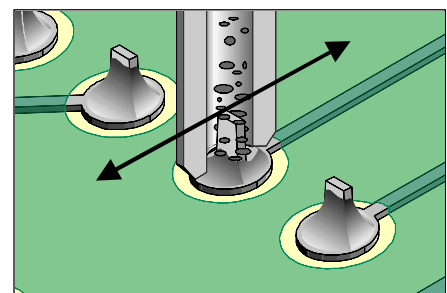

Figure 1: When the solder melts, activate the vacuum to remove the solder while oscillating the tip.



Figure 2: Place a soldering iron tip against the component lead and the desoldering tip over the lead end.

Vacuum Method

Product Class: R/F/W/C x Skill Level: Intermediate x Conformance Level: High Revision C x Page 2 of 3

5. Maintain rotation of the desolder tip while continuous vacuum is being applied. This allows air to cool both the component lead and the plated-through hole preventing the component lead from resweating to the side of the hole.
6. After the solder has been extracted from the solder joint, remove the desolder tip from the component lead while maintaining continuous vacuum.
7. Maintain continuous vacuum for a few seconds to clear the desolder tip.
8. Turn off the vacuum.
9. Desolder each of the remaining component leads individually using a skipping method to reduce thermal buildup at adjacent hole locations.
10. Probe each component lead to be sure that they are not soldered to the side of the plated hole and then remove component.

NOTE

If each lead is not completely free, resolder the joint and repeat steps 2 - 10.

11. Clean the area.

PROCEDURE - Auxiliary Heat Method

Auxiliary heating may be required on solder joints with a large thermal mass. This is most common on multilayer PC boards.

1. Inspect the size of the solder joints on the component to be removed. If the size of the solder joint fillet's are minimal, it may be desirable to add additional solder to form an "excess solder" joint. This will improve the thermal linkage.
2. Apply a small amount of liquid flux to the solder joints of the component to be removed.
3. Place a soldering iron tip against the lead of the component side of the PC board. (See Figure 2)
4. Align the desolder tip with a component lead end and lightly make contact with the solder joint. Keep the desolder tip off the pad by allowing it to slide around on a film of solder.

CAUTION

Do not apply pressure with the solder extractor tip to the lands or other conductive patterns.

Vacuum Method

Product Class: R/F/W/C x Skill Level: Intermediate x Conformance Level: High Revision C x Page 3 of 3

5. After the solder has melted, start a rotating or oscillating motion with the desolder tip. Continue the rotating motion until a change in the "feel" of the rotating motion occurs. At this instant the solder in the solder joint is completely molten. Immediately activate the vacuum, extracting the solder from the solder joint.
6. Maintain rotation of the desolder tip while continuous vacuum is being applied. This allows air to cool both the component lead and the plated-through hole preventing the component lead from resoldering to the side of the hole.
7. After the solder has been extracted from the solder joint, remove the desolder tip and the soldering iron tip from the component lead while maintaining continuous vacuum on the desoldering tip.
8. Maintain continuous vacuum for a few seconds to clear the desolder tip.
9. Turn off the vacuum.
10. Desolder each of the remaining component leads individually using a skipping method to reduce thermal buildup at adjacent hole locations.
11. Probe each component lead to be sure that they are not soldered to the side of the plated hole and then remove component.

NOTE

If each lead is not completely free, resolder the joint and repeat steps 2 - 11.

12. Clean the area.

EVALUATION

1. In-process QA Inspection should be conducted to ensure component was removed without evidence of damage to PC board assembly or plated through hole.

Component Removal, Through Hole Components, Solder Fountain Method

Product Class: R/F/W/C ■ Skill Level: Expert ■ Conformance Level: High

No. 8.1.2

Revision C ■ Page 1 of 4

OUTLINE

This procedure covers the general guidelines for through hole component removal using a solder fountain system.

There is basically only one style of through hole component. Whether there are a few leads or many, or whether the component is large or small, the component removal principles using this method are the same.

CAUTION - Operator Safety

This process uses molten solder and exposes the untrained operator to serious hazards. A thorough review of the equipment manual and comprehensive training are mandatory. Daily maintenance is essential. Consult the equipment manual for more information.

CAUTION - Component Sensitivity

This method may subject the component to extreme temperatures. Evaluate the component's tolerance to heat prior to using this method.

CAUTION - PC Board Sensitivity

PC Boards are made from a great variety of materials. When subjected to the high temperatures of the molten solder used in this method they are susceptible to the following types of damage:

1. Layer delamination.
2. Copper delamination, separation of pads, barrels of inner layers.
3. Burns and solder mask chipping.
4. Warp.

Each PC board must be treated individually and scrutinized carefully for its reaction to heat. If a series of PC boards are to be reworked, the first several should be fully protected until a reliable procedure is established.

REFERENCES

- 1.0 Foreword
- 2.1 Handling Electronic Assemblies
- 2.2 Cleaning
- 2.5 Baking and Preheating
- 7.1.1 Soldering Basics
- 7.1.2 Preparation For Soldering And Component Removal

TOOLS & MATERIALS

Cleaner
Cleaning Wipes
Extractor/Insertion Tools
Flexible Mask
Flux
Flux
Microscope
Oven
Solder
Tape, High Temperature
Solder Fountain System

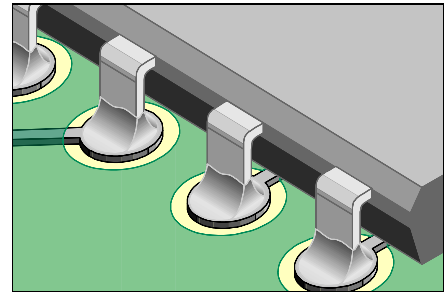

Through Hole Component



Typical solder fountain system.

Solder Fountain System

Most solder fountain systems have the same basic components. A solder pump and solder reservoir, various nozzle sizes and controls for solder flow height.

Solder from the reservoir is driven up through the nozzle by the pump. Nozzles are made of steel with welded seams and connections. It is important that the nozzle construction allow for the capture of the pump's inflow and for the runoff of the solder. This prevents the excess solder from splashing and maintains a usable solder level above the nozzle lip.

Occasionally the opening in the solder fountain table needs to be restricted to prevent solder splash from contaminating the un-worked part of the board. Do not close the opening too tight or you may impede the nozzle run off.

Above the solder fountain head there is generally a light projected alignment mark that permits you to center the part to be removed over the nozzle.

Solder Height Adjustment

Solder height should be set at 1.50 mm - 3.00 mm (.060" - .120") above the lip of the nozzle. The ideal situation is to have the leads of a component just immersed and wetted without having the wave exert any upward pressure on the PC board. The solder fountain table surface should be parallel to the nozzle surface. Components and leads on the bottom side of the PC board may cause the PC board to be uneven, this condition must be compensated for.

Insufficient immersion will prevent proper heat transfer and reflow. Excess pressure will cause solder to surge up through holes and to spill out onto the top side of the PC board.

Solder Temperature Adjustment

Solder temperature adjustment varies depending of various factors. Normal setting 260°C (500° F). During heavy use, solder temperature may cycle between 250°C - 270°C (480°F - 520° F). The heaters should react quickly to normal drops in temperature. The heaters may overshoot the preset temperature when vigorous activity is suddenly halted. Operators must be alert to temperature fluctuations that exceed preset standards.

Solder Fountain Time Adjustment

This adjustment can be used to precisely control operations of a repetitive nature or in instances where you want to strictly control a PC board's exposure to the solder fountain heat.

The timer may also be set to maximum and the on/off action of the wave is controlled by the motor's on/off foot pedal or by lifting the board on and off the wave.

Component Removal, Through Hole Components, Solder Fountain Method

Product Class: R/F/W/C ■ Skill Level: Expert ■ Conformance Level: High

No. 8.1.2

Revision C ■ Page 3 of 4

Removal Tool

There are a variety of removal tools to help extract the component once reflow has been achieved. The extractor tool should provide the operator a good grip but should not unduly damage the component during removal.

PC Board Pre-heat

Recommendations for pre-heat range from 1 to 4 hours at 65°C - 120°C (150°F - 250°F). The requirements of temperature and time for pre-heat depend on the board construction, age and exposure to the atmosphere.

In general terms the pre-heat will serve four purposes.

1. To drive out volatiles or moisture from the PC board. Moisture that has penetrated the board may cause expansion or delamination when it is rapidly heated.
2. To prevent thermal shock to the board. Ambient temperature in buildings in the winter can be as low as 13°C (55°F). As the PC board at this temperature comes in contact with molten solder, the extreme shock of the widely varying temperature may cause surface or internal damage.
3. Pre-heat may permit you to pre expand the PC board. Some PC boards expand so severely at the point of high heat that they will bow up or down enough to create difficulties in maintaining proper board profile to the solder wave.
4. Pre-heat raises the temperature of the PC board and the component to be removed. This allows for quicker component removal. This reduces the potential for burning of solder mask and the PC board surface and reduces potential for other thermal damage.

PROCEDURE - PC Board Preparation

The area surrounding the component to be removed may need protection. If components or the PC board surface are susceptible to damage or exposure to solder they may be protected by using the following procedure:

1. Straighten any leads that may prevent the easy removal of the part.
2. Apply High Temperature Tape to any flat surfaces surrounding the rework area. This tape will insulate the surface from extreme temperatures or apply high temperature flexible mask to protect irregular surfaces. The mask may need baking to provide the proper cure prior to reflow.
3. Select an extractor tool and check the fit to be sure the component can be grabbed easily.

Component Removal, Through Hole Components, Solder Fountain Method

No. 8.1.2

Product Class: R/F/W/C ■ Skill Level: Expert ■ Conformance Level: High

Revision C ■ Page 4 of 4

PROCEDURE - PC Board Pre-heat

PC Boards returned from the field or where they have been exposed to moisture for some time.

1. Bake for 4 hours at approximately 75°C (165°F). Prior to part removal the PC board should be pre-heated for one hour prior to removal of the part. If possible perform reflow immediately upon removal of the PC board from the oven after completion of the baking cycle. If the PC board must sit between the pre-heat and removal, it may sit for the maximum of one night only in a dry atmosphere.
2. Top heat during removal is only used when working with the most difficult components. To apply top heat, a heat gun is positioned directly above the solder nozzle at a set distance above the PC board surface. Top heat is applied for a set time prior to activating the solder fountain. Heat sensitive chalk applied to the component will signal when the proper temperature has been achieved.

NOTE

Other component temperature indication techniques can be used.

PROCEDURE - Removal Process

1. Turn on the solder fountain system and allow the solder to reach the proper operating temperature. Clean the machine as needed and test run the pump to be sure there is no buildup of contamination that may cause a drag on the pumping system.
2. Select the proper nozzle and install it into the solder fountain system. A nozzle that is too large will expose the PC board surface to unnecessary heat. A nozzle that is too small may not reflow all the component leads.
3. Check the table height and solder wave height to be sure they are properly set for the PC board to be worked on.
4. Apply flux to all the leads of the component to be removed. Apply the flux to both the top and bottom side solder fillets.
5. Place the PC board over the nozzle. Check the position using the alignment light.
6. Activate the solder fountain. Once full solder reflow has been achieved extract the component with the extractor tool. Operator skill and experience are required to prevent hole and pad damage caused by premature removal or from heat damage due to delayed removal.
7. Immediately drop the solder fountain to prevent over exposure.
8. Allow the PC board to cool before handling and inspection.
9. Clean the area and inspect for signs of damage.

Forked Tip Method

Product Class: R/F/W/C ■ Skill Level: Intermediate ■ Conformance Level: High

Revision C ■ Page 1 of 2

OUTLINE

This procedure covers one commonly used method for removing surface mount chip components.

NOTE

The goal when removing any component is to remove the component as quickly as possible.

CAUTION - Glued Components

A small dot of epoxy is often used to hold chip components in position during wave soldering processing. Typically these components will be located on the bottom side of a PC board that has through hole components located on the other side. Whenever you see a board like this, you can generally assume that the chip components will be glued onto the board. You'll need to leave the tip on the component for one or two additional seconds in order to transfer enough heat to overcure or soften the adhesive. If required take a wooden stick or curved tweezers and push the component sideways until the glue joint finally gives way.

REFERENCES

- 1.0 Foreword
- 2.1 Handling Electronic Assemblies
- 2.2 Cleaning
- 2.5 Baking and Preheating
- 7.1.1 Soldering Basics
- 7.1.2 Preparation For Soldering And Component Removal

TOOLS & MATERIALS

- Caliper
- Cleaner
- Cleaning Wipes
- Flux
- Microscope
- Soldering Removal Tool with Tips

TIP PREPARATION

Forked tips are designed to fit over the top of chip components, and to reflow both solder joints at once. The ends of the forked tip fit over the component with just a slight amount of extra space for solder. Measure the overall length and width of the component with a caliper to select the proper size tip. Check the tip for proper fit prior to processing the part.

The tip should not fit the component so tightly that it will get lodged in the tip, but the tip should not be so loose that it will not conduct heat to the leads simultaneously. The size and shape of the forked tip will have an effect on the rate of heat transfer. Larger tips with more surface area will transfer heat faster than smaller tips.

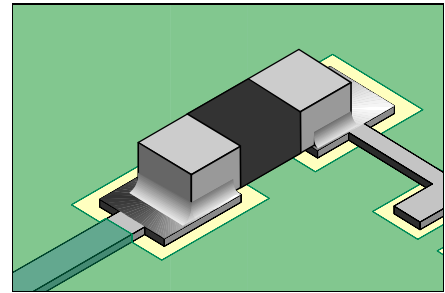

Surface Mount Chip Component

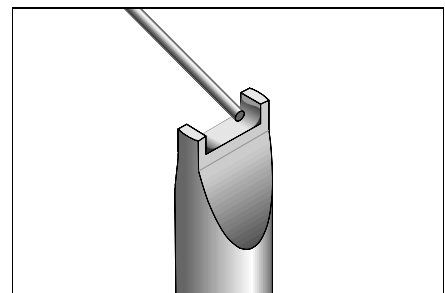

Figure 1: Forked tip shown with solder added to cavity to enhance removal operation.

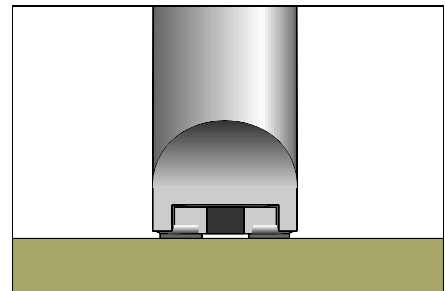

Figure 2: Removing SMT chip component with forked tip. After solder has melted lift tip out and up.

Forked Tip Method

Product Class: R/F/W/C ■ Skill Level: Intermediate ■ Conformance Level: High

Revision C ■ Page 2 of 2

Forked tips can be used to remove a number of different styles of chip components but the component must fit properly in the tool cavity. Since forked tips have a cavity, they require special cleaning and tinning procedures.

1. Remove any solder from inside the tip cavity with a fiber tool.

CAUTION

Do not use a wire brush for any tip cleaning procedure. A wire brush can severely scratch a metal tip. Scratches allow oxidation to form on the base metal of the tip and this will severely decrease the useful life.

2. Remove any oxidized solder by shocking the tip on a wet sponge.
3. Add solder to the properly prepared tip. Fill the cavity until there is a fillet on each side of the tip. (See Figure 1). Add enough solder to help transfer the heat quickly but not so much that it will fall out when the tip is turned upside down.

The solder provides surface tension to lift the component off the pads after reflow. Since the tip has more metal surface area than the pads on the PC board, the solder will be drawn toward the metal tip and so will the component.

NOTE

Determine the direction the part is to be swept off the PC board surface. Densely packed PC board assemblies often leave only one direction for the rework tool to follow when sweeping the part off the surface.

PROCEDURE

1. Apply a small amount of liquid flux to both ends of the component.
2. Place the forked tip directly over the top of the component. The extra solder on the tip will melt both solder joints. When the solder has melted slide the component out and up. (See Figure 2).

Once the component is removed from the PC board it can be removed from the tip by the shocking sponge or with a dull blunt instrument applying downward pressure on the component.

3. Clean the area.

Component Removal, Surface Mount Chip Components, Hot Tweezer Method

No. 8.2.2

Product Class: R/F/W/C ■ Skill Level: Intermediate ■ Conformance Level: High

Revision C ■ Page 1 of 1

OUTLINE

This procedure covers one commonly used method for removing surface mount chip components.

NOTE

The goal when removing any component is to remove the component as quickly as possible.

CAUTION - Glued Components

A small dot of epoxy is often used to hold chip components in position during wave soldering processing. Typically these components will be located on the bottom side of a PC board that has through hole components located on the other side. Whenever you see a board like this, you can generally assume that the chip components will be glued onto the board. You'll need to leave the tip on the component for one or two additional seconds in order to transfer enough heat to overcure or soften the adhesive. If required take a wooden stick or curved tweezers and push the component sideways until the glue joint finally gives way.

REFERENCES

- 1.0 Foreword
- 2.1 Handling Electronic Assemblies
- 2.2 Cleaning
- 2.5 Baking and Preheating
- 7.1.1 Soldering Basics
- 7.1.2 Preparation For Soldering And Component Removal

TOOLS & MATERIALS

Caliper
Cleaner
Cleaning Wipes
Flux
Hot Tweezer Tool with Tips
Microscope
Solder

NOTE

Determine the direction the part is to be swept off the PC board surface. Densely packed PC board assemblies often leave only one direction for the rework tool to follow when sweeping the part off the surface.

PROCEDURE

1. Tin the hot tweezer tip.
2. Apply a small amount of liquid flux to both ends of the component.
3. Place the tweezer tips in contact with both ends of the component. When the solder melts, lift the component off the PC board. (See Figure 1).
4. Clean the area.

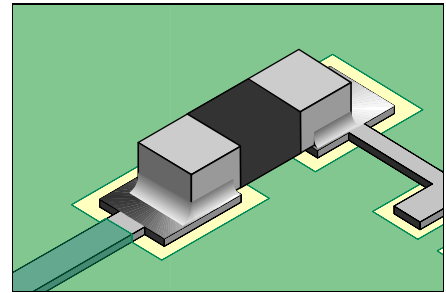

Surface Mount Chip Component

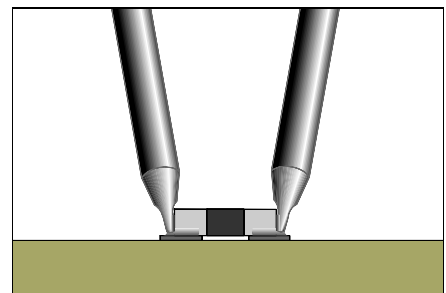

Figure 1: Place the tweezer tips in position. When the solder melts, lift the component off the PC board.

Component Removal, Surface Mount J Lead Components, Conduction Method

No. 8.3.1

Product Class: R/F/W/C ■ Skill Level: Advanced ■ Conformance Level: High

Revision C ■ Page 1 of 2

OUTLINE

This procedure covers one commonly used method for removing surface mount J lead components.

NOTE

The goal when removing any component is to remove the component as quickly as possible

REFERENCES

- 1.0 Foreword
- 2.1 Handling Electronic Assemblies
- 2.2 Cleaning
- 2.5 Baking and Preheating
 - 7.1.1 Soldering Basics
 - 7.1.2 Preparation For Soldering And Component Removal

TOOLS & MATERIALS

- Caliper
- Cleaner
- Cleaning Wipes
- Conduction Removal Tool with Tips
- Flux, Liquid
- Microscope
- Oven
- Positioning Table
- Rework Stand
- Soldering Iron with Tips

PREPARATION

This method uses tips that are designed to fit over the top of surface mount components, and to reflow all the solder joints at once. The tip fits over the component with just a slight amount of extra space for solder. Measure the overall length and width of the component with a caliper to select the proper size tip. Check the tip for proper fit prior to processing the part.

The tip should not fit the component so tightly that it will get lodged in the tip, but the tip should not be so loose that it will not conduct heat to all the leads simultaneously

Conduction tips come in several sizes to accommodate many of the different styles and sizes of components, but the component must fit properly in the tool cavity. Since these tips have a cavity, they require special cleaning and tinning procedures.

NOTE

Carefully inspect the tip to ensure that all surfaces will properly contact the component leads.

1. Remove any solder from inside the tip cavity with a fiber tool.

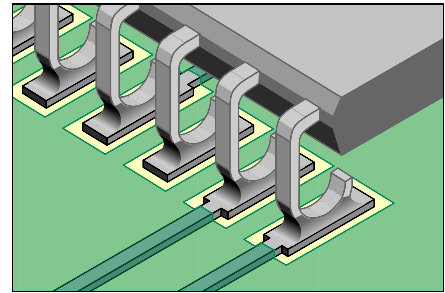

**Surface Mount
J Lead Component**

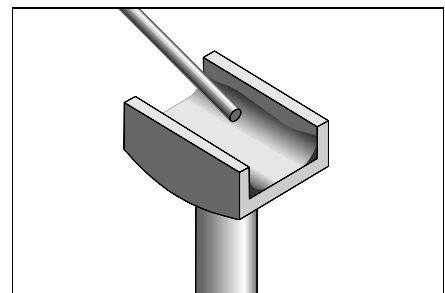

Figure 1: Conduction tip shown with solder added to enhance removal operation.

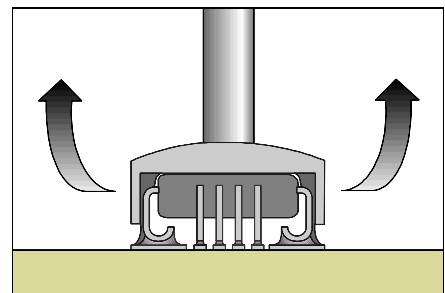

Figure 2: Removing J lead component with conduction tip. After solder has melted lift tip out and up.

CAUTION

Do not use a wire brush for any tip cleaning procedure. A wire brush can severely scratch a metal tip. Scratches allow oxidation to form on the base metal of the tip and this will severely decrease the useful life.

2. Remove any oxidized solder by shocking the tip on a wet sponge. Remove stubborn charred residue using an orange stick or polishing bar.
3. Add solder to the properly prepared tip. Fill the cavity until there is a fillet on the entire length of each side of the tip. (See Figure 1). Add enough solder to help transfer the heat quickly but not so much that it will fall out when the tip is turned upside down. The entire conducting surface of the tip should be tinned with solder to promote proper heat transfer to the leads of the component to be removed.

The solder provides surface tension to lift the component off the pads after reflow. Since the tip has more metal surface area than the pads on the PC board, the solder will be drawn toward the metal tip and so will the component.

NOTE

Determine the direction the part is to be swept off the PC board surface. Densely packed PC board assemblies often leave only one direction for the rework tool to follow when sweeping the part off the surface.

PROCEDURE

1. Apply a small amount of liquid flux to all leads of the component.
2. Place the tip directly over the top of the component. The extra solder on the tip will melt all the solder joints. When the solder has melted slide the component out and up. (See Figure 2).

It's difficult to precisely know how long to dwell prior to safely removing the part. This is complicated by the fact that when removing a bank of components, parts subsequent to the first come off much faster. Obviously, the smaller the part the quicker it reflows. Small SMT components may reflow in a few seconds and large SMT components may take more than a minute.

On the smaller components you can usually see solder reflow and can then sweep the component off and up. On larger components it is wise to attempt to view reflow but often this is not possible. If you cannot clearly see reflow very lightly rock the component to test for movement. If the component moves freely then it is ready to be swept off the pads and lifted up.

Once the component is removed from the PC board it can be removed from the tip by the shocking sponge or with a dull blunt instrument applying downward pressure on the component.

3. Clean the area.

Hot Gas/Air Method

OUTLINE

This procedure covers one commonly used method for removing surface mount J lead components.

NOTE

The goal when removing any component is to remove the component as quickly as possible

REFERENCES

- 1.0 Foreword
- 2.1 Handling Electronic Assemblies
- 2.2 Cleaning
- 2.5 Baking and Preheating
 - 7.1.1 Soldering Basics
 - 7.1.2 Preparation For Soldering And Component Removal

TOOLS & MATERIALS

- Caliper
- Cleaner
- Cleaning Wipes
- Flux, Liquid
- Hot Air Removal Tool with Tips
- Microscope
- Oven
- Positioning Table
- Rework Stand
- Vacuum Pen

PREPARATION

This method uses hot air nozzles that do not touch the component. Gas or air is heated and forced through a specially designed nozzle and directed onto the component leads and surface pads.

Hot gas/air nozzles come in several sizes to accommodate many of the different styles and sizes of components. Measure the overall length and width of the component to select the proper size tip. Check the nozzle for proper fit prior to processing the part. Some hot gas/air nozzle designs will heat only the component leads and pad area. (See Figure 1, Left Side). Some hot air nozzle designs heat the entire component, the leads and pad area. (See Figure 1, Right Side).

Hot gas/air can be used to remove a number of different styles of SMT components but the heated gas/air must be directed onto the leads and pads and away from the top of the component and PC board surface.

Hot gas/air nozzles may or may not include vacuum assistance to lift the component off the PC board surface.

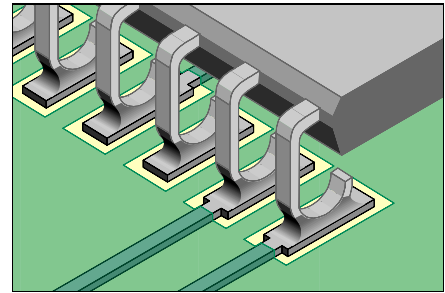

**Surface Mount
J Lead Component**

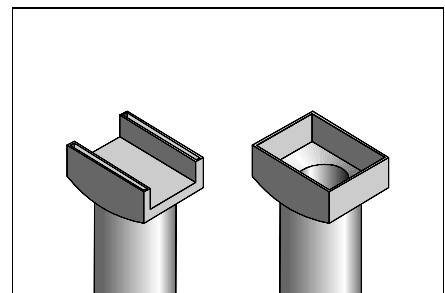

Figure 1: Nozzle at left heats the leads and pads. Nozzle at right heats component, leads and pads.

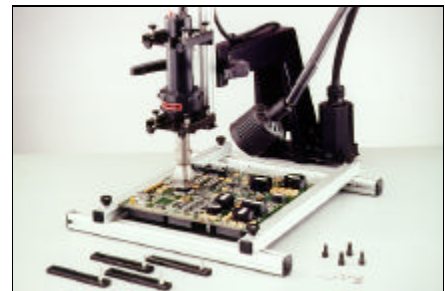

Figure 2: Rework stand holds hot air rework tool steady and positioning table keeps PC board level.

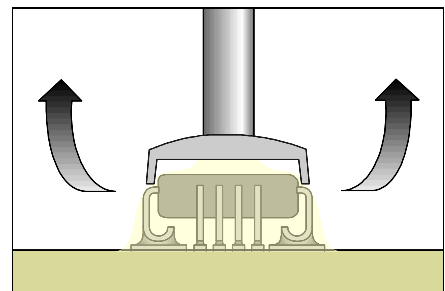

Figure 3: After solder has melted lift component straight up.

PROCEDURE

1. Place the pre-heated PC board on the positioning table. A heated positioning table is available to pre-heat the PC board, or can be used to maintain the pre-heated temperature when many components need to be removed from one PC board. (See Fig. 2).
2. Apply a small amount of liquid flux to all leads of the component.
3. Place the nozzle directly over the top of the component and activate the air flow. When the solder has melted actuate the vacuum assist or lift off the component with a vacuum pen. Lift the component straight up. (See Figure 3).

It's difficult to precisely know how long to dwell prior to safely removing the part. This is further complicated by the fact that when removing a bank of components, parts subsequent to the first come off much faster. Obviously, the smaller the part the quicker it reflows. Small SMT components may reflow in a few seconds and large SMT components may take more than a minute.

4. Clean the area.

Component Removal, Surface Mount Gull Wing Components, Conduction Method

No. 8.4.1

Product Class: R/F/W/C x Skill Level: Advanced x Conformance Level: High

Revision C x Page 1 of 2

OUTLINE

This procedure covers one commonly used method for removing surface mount Gull Wing components.

NOTE

The goal when removing any component is to remove the component as quickly as possible

REFERENCES

- 1.0 Foreword
- 2.1 Handling Electronic Assemblies
- 2.2 Cleaning
- 2.5 Baking and Preheating
- 7.1.1 Soldering Basics
- 7.1.2 Preparation For Soldering And Component Removal

TOOLS & MATERIALS

- Caliper
- Cleaner
- Cleaning Wipes
- Conduction Removal Tool with Tips
- Flux, Liquid
- Microscope
- Oven
- Positioning Table
- Rework Stand
- Soldering Iron with Tips

PREPARATION

This method uses tips that are designed to fit over the top of surface mount components, and to reflow all the solder joints at once. The tip fits over the component with just a slight amount of extra space for solder. Measure the overall length and width of the component with a caliper to select the proper size tip. Check the tip for proper fit prior to processing the part.

The tip should not fit the component so tightly that it will get lodged in the tip, but the tip should not be so loose that it will not conduct heat to all the leads simultaneously

Conduction tips come in several sizes to accommodate many of the different styles and sizes of components, but the component must fit properly in the tool cavity. Since these tips have a cavity, they require special cleaning and tinning procedures.

NOTE

Carefully inspect the tip to ensure that all surfaces will properly contact the component leads.

1. Remove any solder from inside the tip cavity with a fiber tool.

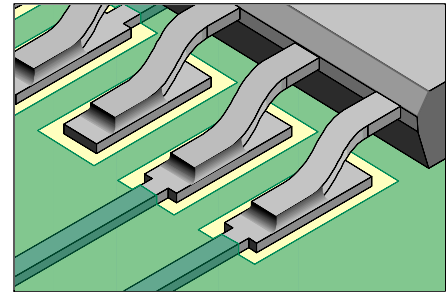

**Surface Mount
Gull Wing Component**

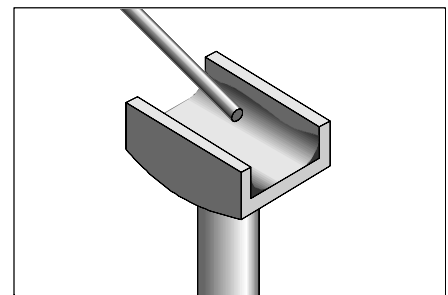

Figure 1: Conduction tip shown with solder added to enhance removal operation.

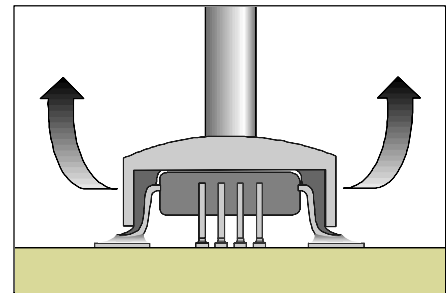

Figure 2: After solder has melted lift tip out and up.

CAUTION

Do not use a wire brush for any tip cleaning procedure. A wire brush can severely scratch a metal tip. Scratches allow oxidation to form on the base metal of the tip. This will decrease the useful life.

2. Remove any oxidized solder by shocking the tip on a wet sponge. Remove stubborn residue using an orange stick or polishing bar.
3. Add solder to the properly prepared tip. Fill the cavity until there is a fillet on the entire length of each side of the tip. (See Figure 1). Add enough solder to help transfer the heat quickly but not so much that it will fall out when the tip is turned upside down. The entire conducting surface of the tip should be tinned with solder to promote proper heat transfer to the leads of the component to be removed.

The solder provides surface tension to lift the component off the pads after reflow. Since the tip has more metal surface area than the pads on the PC board, the solder will be drawn toward the metal tip and so will the component.

NOTE

Determine the direction the part is to be swept off the PC board surface. Densely packed PC board assemblies often leave only one direction for the rework tool to follow when sweeping the part off the surface.

PROCEDURE

1. Apply a small amount of liquid flux to all leads of the component.
2. Place the tip directly over the top of the component. The extra solder on the tip will melt all the solder joints. When the solder has melted slide the component out and up. (See Figure 2).

It's difficult to precisely know how long to dwell prior to safely removing the part. This is complicated by the fact that when removing a bank of components, parts subsequent to the first come off much faster. Obviously, the smaller the part the quicker it reflows. Small SMT components may reflow in a few seconds and large SMT components may take more than a minute.

On the smaller components you can usually see solder reflow and can then sweep the component off and up. On larger components it is wise to attempt to view reflow but often this is not possible. If you cannot clearly see reflow very lightly rock the component to test for movement. If the component moves freely then it is ready to be swept off the pads and lifted up.

Once the component is removed from the PC board it can be removed from the tip by the shocking sponge or with a dull blunt instrument applying downward pressure on the component.

3. Clean the area.

Hot Gas/Air Method

Product Class: R/F/W/C x Skill Level: Advanced x Conformance Level: High

Revision C x Page 1 of 2

OUTLINE

This procedure covers the most commonly used methods for removing surface mount Gull Wing components.

NOTE

The goal when removing any component is to remove the component as quickly as possible

REFERENCES

- 1.0 Foreword
- 2.1 Handling Electronic Assemblies
- 2.2 Cleaning
- 2.5 Baking and Preheating
- 7.1.1 Soldering Basics
- 7.1.2 Preparation For Soldering And Component Removal

TOOLS & MATERIALS

- Caliper
- Cleaner
- Cleaning Wipes
- Flux, Liquid
- Hot Air Removal Tool with Tips
- Microscope
- Oven
- Positioning Table
- Rework Stand
- Vacuum Pen

PREPARATION

This method uses hot air nozzles that do not touch the component. Gas or air is heated and forced through a specially designed nozzle and directed onto the component leads and surface pads.

Hot gas/air nozzles come in several sizes to accommodate many of the different styles and sizes of components. Measure the overall length and width of the component to select the proper size tip. Check the nozzle for proper fit prior to processing the part. Some hot gas/air nozzle designs will heat only the component leads and pad area. (See Figure 1, Left Side). Some hot air nozzle designs heat the entire component, the leads and pad area. (See Figure 1, Right Side).

Hot gas/air can be used to remove a number of different styles of SMT components but the heated gas/air must be directed onto the leads and pads and away from the top of the component and PC board surface.

Hot gas/air nozzles may or may not include vacuum assistance to lift the component off the PC board surface.

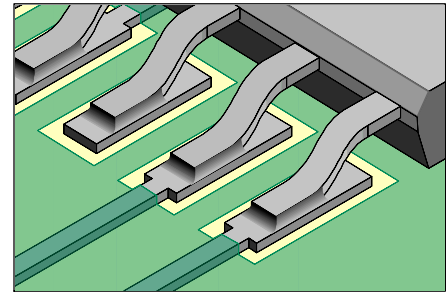

**Surface Mount
Gull Wing Component**

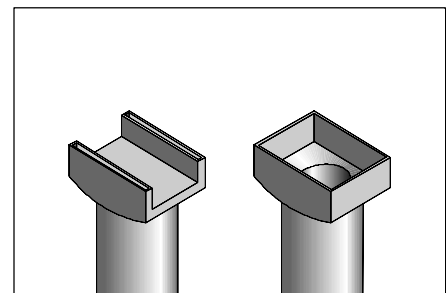

Figure 1: Nozzle at left heats the leads and pads. Nozzle at right heats component, leads and pads.

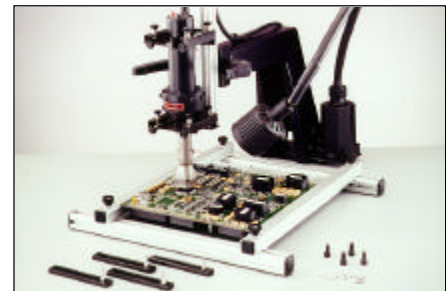

Figure 2: Rework stand holds hot air rework tool steady and positioning table keeps PC board level.

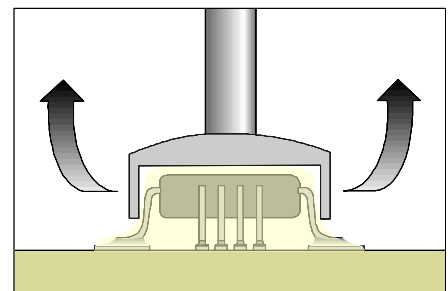

Figure 3: After solder has melted lift component straight up.

PROCEDURE

1. Place the pre-heated PC board on the Positioning Table. A heated positioning table is available to pre-heat the PC board, or can be used to maintain the pre-heated temperature when many components need to be removed from one PC board. (See Figure 2).
2. Apply a small amount of liquid flux to all leads of the component.
3. Place the nozzle directly over the top of the component and activate the air flow. When the solder has melted actuate the vacuum assist or lift off the component with a vacuum pen. Lift the component straight up. (See Figure 5).

It's difficult to precisely know how long to dwell prior to safely removing the part. This is further complicated by the fact that when removing a bank of components, parts subsequent to the first come off much faster. Obviously, the smaller the part the quicker it reflows. Small SMT components may reflow in a few seconds and large SMT components may take more than a minute.

4. Clean the area.

